

Please read this manual  
before use!

Manual



## Gasoline motor pump

KS 50

KS 80

KS 80TW

KS 50HP

KS 80MW

KS 80CW

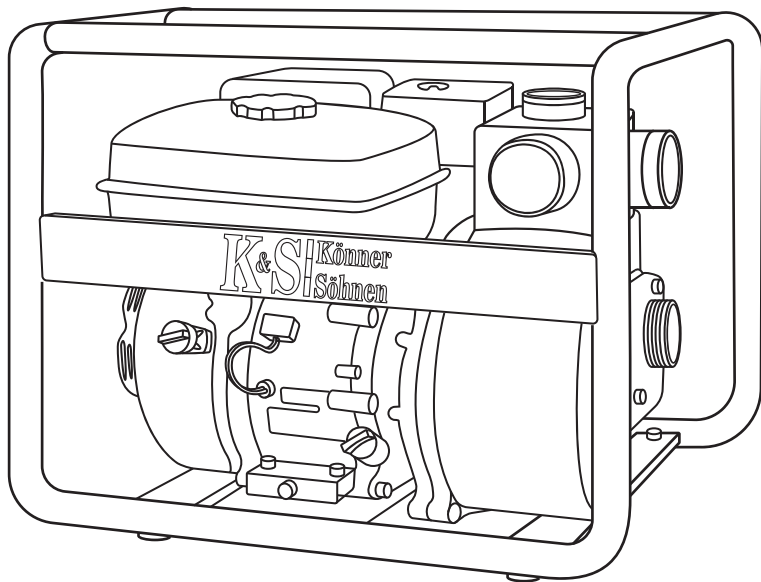



Thank you for your purchase of **Könner & Söhnen** products. This manual contains a brief description of safety, use and debugging. More information can be found on the official manufacturer's website in the support section: [ks-power.de/betriebsanleitungen](http://ks-power.de/betriebsanleitungen).

You can also go to the support section and download the full version of the manual by scanning the QR code, or on the website of the official importer of **Könner & Söhnen** products: [www.ks-power.de/en](http://www.ks-power.de/en).



**Be sure to read the full version of the manual before getting started!**



Manufacturer reserves the right to make alterations into the devices, which may not be reflected in this manual. Pictures and photos of the product may vary from its actual appearance. At the end of this manual, You may find contact information which you are free to use in case of any issues occurrence.

All data, specified in this operation manual is the most up to date for the moment of its publishing. The current list of service centers you can find at the website of official importer: [www.ks-power.de/en](http://www.ks-power.de/en).

## TECHNICAL DATA

1

Motor pump	KS 50	KS 80	KS 80TW	KS 50HP	KS 80MW	KS 80CW
Engine model	KS 200	KS 200	KS 250	KS 250	KS 280	KS 250
Engine volume, cm <sup>3</sup>	196	196	212	212	269	212
Engine power, hp	6,5	6,5	7,0	7,0	9,0	7,0
Fuel tank, l	3,6	3,6	3,6	3,6	6,0	3,6
Oil crankcase volume, l	0,6	0,6	0,6	0,6	1,1	0,6
Noise level L <sub>PA</sub> (7m)/L <sub>WA</sub> , dB	79/104	79/104	79/104	79/104	79/104	79/104
Maximal productivity, l/min	500	1000	1100	500	1000	1000
Nominal speed, r/min	3600	3600	3600	3600	3600	3600
Maximal height of lifting, m	28	28	26	50	20	26
Maximal depth of suction, m	7	7	7	7	7	7
Diameter of inlet pipe, mm	50	80	80	50	80	80
Diameter of outlet pipe, mm	50	80	80	40/50/40	80	80
Dimensions (L*W*H), mm	510×440×440	510×440×440	540×470×450	495×445×445	725×540×600	605×435×480
Weight, kg	24	26	35	29	60	28



**IMPORTANT!**



**Clean water pump and high pressure pump are only designed for pumping clean water. Trash water pump has the capability of transmitting soft solids within the diameter of 25.4 mm.**

**ONLY chemical pumps is used for transmission of weak acid and base (PH7 - 8.5), high ignition temperature liquid and sea water.**

**Mud pump is suitable for pumping dirt water with up to 50% solid sewerage, capacity up to diameter of 25.4 mm.**

The delivery package includes:

Motor pump - 1 pc.  
Filter - 1 pc.  
Hose fitting set - 1 pc.

Operation Manual - 1 pc.  
Packing - 1 pc.

### GENERAL FORM AND COMPONENTS OF GASOLINE MOTOR PUMP

Fig.1

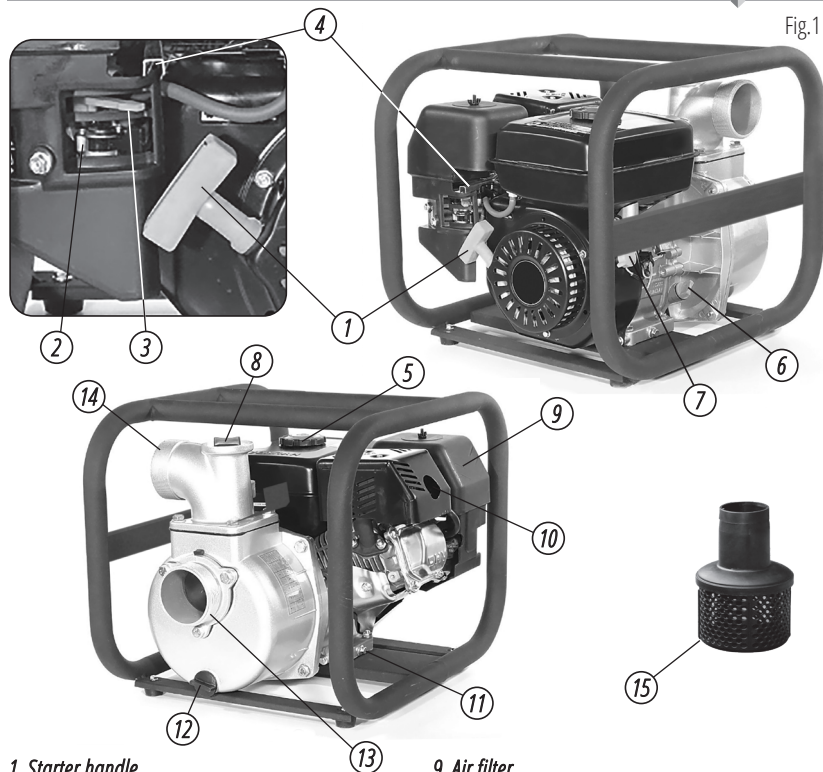

1. Starter handle
2. Fuel valve
3. Air throttle
4. Throttle valve
5. Fuel tank cover
6. Oil filler
7. Ignition switch
8. Cover for filling of motor pump with water

9. Air filter
10. Silencer
11. Engine crankcase plug
12. Pump crankcase plug
13. Water pumping port
14. Water outlet port
15. Inflation filter

### SAFETY INFORMATION



**IMPORTANT!**



Using device for other purposes deprives the right for free warranty. Improper use of the device deprives the buyer of the right to have free warranty repairs.

- Please learn how you can stop engine and motor pump units during their operation fast, properly and safely.
- The gasoline motor pump shall be put into operation only by people in good mental and physical condition.
- Never use motor pump after drinking alcohol or using drugs as well as medicine which can exert negative influence on the worker reaction.
- Keep gasoline motor pump **Könner & Söhnen** during operation not less than 1 meter apart from buildings and equipment.



**Never pump chemical solutions, high-active, combustible, caustic liquid substances, solvents or gasoline with motor pump!**

**ONLY chemical pumps is used for transmission of weak acid and base (PH7 - 8.5), high ignition temperature liquid and sea water.**

**DANGER FOR LIFE AND HEALTH**

- Third parties, children or animals shall be never situated in close proximity to the working area of motor pump.
- The motor pump **Könner & Söhnen** meets all requirements of European safety standards. Any changes cannot be made to device construction without permission.
- The engine and outlet pipe shall be always clean. If oil or fuel leaks, clean up all dirty surfaces immediately.

**GASOLINE IS A TOXIC AND FLAMMABLE LIQUID!**

- Do not move and transport the device with open fuel tank valve (if any). The fuel tank shall be empty.
- Please tank the device only outdoor, far away from ignition or inflammation sources. No smoking during motor pump filling.
- Do not fill fuel tank completely. Please fill tank with fuel 4 cm below the fuel tube edge so that there is the place for fuel extension.
- Do not open gasoline tank cover and add gasoline during engine operation or without waiting of its cooling after operation.
- If the gasoline overflows, clean up a surface covered with gasoline thoroughly before starting the engine.
- During engine operation the motor pump evolves exhaust gases which are poisonous for human organism. Do not use device in closed or poorventilated areas – it is dangerous for user life and health!



**Fuel contaminates the land and groundwater. Do not allow the leaking gasoline from the tank!**

**SAFETY SYMBOLS DESCRIPTION**

- a.** Be careful when using the device! Follow safety rules listed in manual.
- b.** Use the motor pump only in areas that are well ventilated, or on open areas. The exhaust gases contain CO<sub>2</sub>, which are dangerous to life.
- c.** Do not use or store the device in high humidity.
- d.** Do not smoke when using the pump!
- e.** Follow safety precautions to avoid electric shock.
- f.** Carefully read the manual before using the device.
- g.** Do not touch the pump with dirty hands.
- h.** Follow fire safety rules, do not use open flames near the pump.
- i.** Please don't touch! The muffler heats up when running the pump.

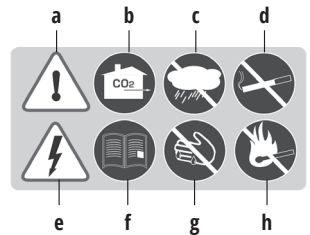

## OTHER SYMBOLS DESCRIPTION

Specification table. For different models this table is different. All characteristics are given in the «Specifications».

<b>K&amp;S</b> Könner & Söhnen	Model: KS ECHP GASOLINE PUMP POMPA BENZYNOWA
MAX. ENGINE POWER, HP MOC SILNIKA WAKS., KM	7.0
SUCTION DEPTH WYSOKOSC SSANIA	8 m
LIFT HEIGHT WYSOKOSC TLOCZENIA	70 m
MAX PRODUCTIVITY MKS: WYDAJNOSC	500 l/min
DIAMETER OF INLET PIPE SREDNICA RURY WJESCIOWEJ	50 mm
DIAMETER OF OUTLET PIPE SREDNICA RURY WYJSCIOWEJ	38/38/50 mm
PROTECTION CLASS STOPNIEK OCHRONY	IP 20
WEIGHT WAGA	27 kg
YEAR OF ISSUE ROK PRODUKCJI	2017
SERIAL NUMBER IS MARKED ON THE ENGINE NUMER SERIJNY JEST WYTLOCZONY NA SILNIKU Manufacturer DIMAX International GmbH, Hauptstr. 134, 51143 Cologne, Germany, www.ks-power.de Producer DIMAX International GmbH, ul. Hauptstr., 134, 51143 Kolonia, Niemcy, zmont. w CR. Importer do Polski: DIMAX International Poland Sp. z o.o. Swieradowska 47, 02-662 Warszawa, Polska. www.ks-power.pl	
Könner & Söhnen, Germany	



Marking speed control: MAX - MIN



Caution about gasoline



To start engine, put handle of air damper into position «CLOSED» ( move according to direction of arrow)

Fuel valve ( move to position «OPEN» in the direction of the arrow)



Information on the required level of oil in the crankcase



Indicates the noise level.

## PREPARING TO WORK

5

## CONNECT THE INJECTION HOSE AND WATER DISCHARGE HOSE

5.1

### WATERFLOOD HOSE

When operating the motor pump, please always use special nondeformable reinforced thick-wall waterflood hose. The suction tube shall be corrugated, because it works in compression. Fix the hose on the port with special fixation ring.



ATTENTION - DANGER!

Always set pumping filter at the end of hose before operation.

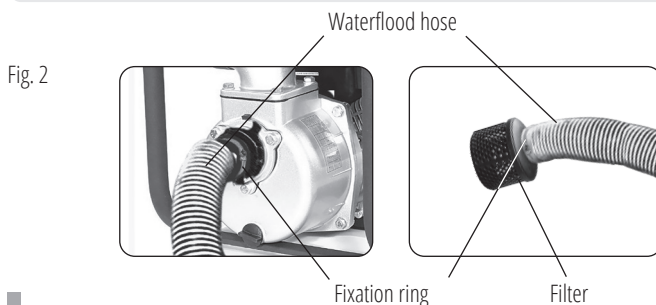

Fig. 2

### WATER OUTLET HOSE

The water outlet hose is kept under the pressure. Please take it into account and always use ring for the fixation. It concerns especially fabric hoses.



IMPORTANT!



Remember! To improve efficiency of pump operation, please use short and wide hose for water drag reduction.

Fill the crankcase with engine oil SAE 10W-30 or SAE 10W-40. Please check oil level every time before starting the motor pump engine!



**IMPORTANT!**



**Please use only engine oil for 4-stroke engines.**

Fig. 3

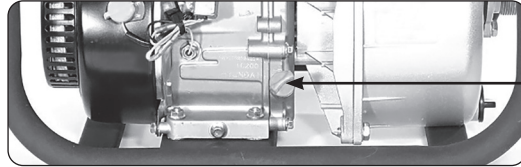

Oil filler cover

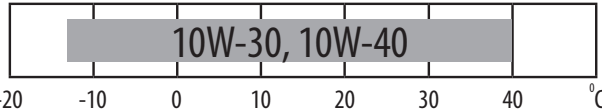

The engine oil selection depends on climatic zone. For general use in many climatic zones it is usually recommended to use oil SAE 10W-30 or SAE 10W-40.

**To check oil level, please follow this sequence:**

- Ensure that the engine is inoperative and cold.
- Open the oil filler cover and wipe dry gage rod.
- Insert gage rod in the filler without its rotating. Check the level.
- If the oil level is low, fill the lubricant neck to the edge.

FILLING AND FUEL UTILIZATION

5.3

Add fuel to the fuel tank. Make sure a fuel filter is installed in the filler neck of the fuel tank.



**IMPORTANT!**



**Only unleaded gasoline is recommended for the motor pump.**

To check fuel level, please open fuel tank cover. If the fuel level is low, please fill the tank. Do not fill fuel tank to the top of filler! Leave some space for gasoline extension.



**ATTENTION - DANGER!**



- Gasoline is a flammable and explosive!
- Fill the motor pump only when stopping the engine and in the well-ventilated room.
- Do not operate motor pump near open fire. No smoking during its operation.
- The fuel level shall be lower than fuel tank filler. Do not let overflow fuel tank. Ensure that the tank cover is tightly closed after refilling. Be careful of fuel spillage during refilling because spilled gasoline or its vapor catch fire easily.
- Do not breathe in gasoline vapor. Do not contact for a long time with gasoline.
- Do not use contaminated or stale gasoline or oil-gasoline mixture.
- Please control that no dust or water get to the fuel tank.



**ATTENTION - DANGER!**



**Keep fuel away from children!**

## AIR FILTER 5.4

Before getting started, be sure to check the correct position of the air filter (fig. 12). Please clean air filter regularly to avoid unstable operation of carburetor. Please do it as often as possible if the motor pump is operated under special contaminated conditions.

## WATER PUMPING 5.5

Before getting started, be sure to fill the pump with clean water close to the top of the filler neck (fig. 4)  
The pump should be stopped about 30 seconds (but no more than 2.5 minutes) after its start (depending on the hose length) and water should be added to the pump in order to increase its performance.

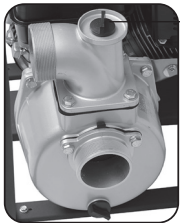

Cover for filling of motor pump with water

Fig. 4



**To avoid motor pump overheating, do not start it without its prefilling with water. If motor pump ran dry, stop it immediately and let it cool before filling with water.**

## STARTUP 6

### CORRECT POSITIONING OF THE PUMP

The pump must be installed **no higher than 7 meters** from the water surface to the suction port

Check the immersion depth of the hose as the pump can operate without water for no more than 20 seconds.

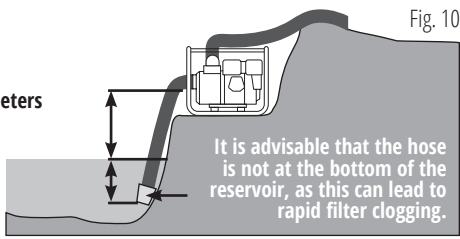

Fig. 10

### ENGINE STARTING

- Turn the fuel valve (A) to ON.
- To start cold engine, move the air throttle lever (B) to CLOSE. When the engine heat up, please turn on the throttle to OPEN.
- Switch the ignition switch (C) to ON.

Fig. 5

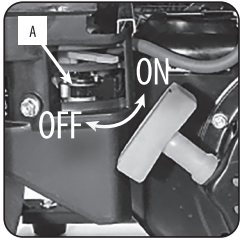

Fig. 6

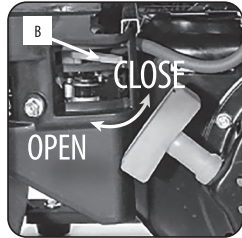
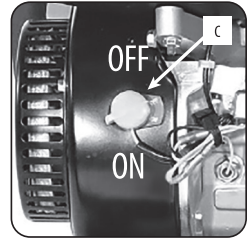

Fig. 7



- Move the throttle valve (D) to the left end position.

Fig. 8

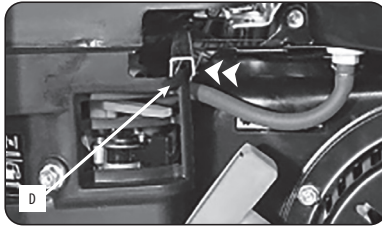
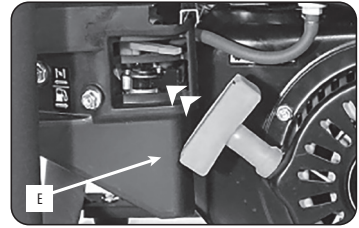
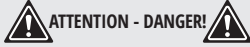

Fig. 9



- Start engine with hand starter (E).



**To avoid starter damage, turn its handle continuously into position without leaving it.**

- Set the desired engine speed by smoothly turning the throttle valve (D) to the "FAST" or "SLOW" position. After starting engine please ensure that motor pump supplies water. If it doesn't occur, please turn off the engine.

The water lag is permitted if it doesn't exceed 2,5 minutes. Please turn off the engine if water supply didn't start after expected waiting time.

In order to increase the pump's performance, be sure to stop the pump 30 seconds after its start (depending on the hose length) and add water through the filling cap (fig. 4). After that resume pump operation.

## ENGINE STOPPING

To stop engine safely and properly, please follow this sequence:

- Move the throttle valve (D) to SLOW.
- Switch the ignition switch (C) to OFF.
- Turn the fuel valve (A) to OFF.



**For emergency stop of engine switch the ignition switch (C) to OFF. In all other cases please follow above mentioned sequence.**

## MAINTENANCE OPERATION

7



**Exhaust gases contain poisonous carbon monoxide. Stop the engine before performing any maintenance work. Before starting engine ensure that the room is wellventilated.**

Recommendations of motor pump maintenance and inspection in appointed time intervals are listed in the table below.



## TECHNICAL MAINTENANCE WORKS

Routine maintenance service is carried out in the each appointed time interval		Each start	First month or 20 hours	Every 3 months or 50 hours	Every 6 months or 100 hours	Once a year or 300 hours
Engine oil	Check	☑				
	Replacement		☑	☑		
Air filter	Check	☑				
	Cleaning		☑			
	Replacement			☑ <sup>(1)</sup>		
Fuel tank	Cleaning					☑
Spark plug	Gap check and control			☑		
	Replacement				☑	
Pump inlet valve	Check					☑ <sup>(2)</sup>
Fuel filter (in fuel tank)	Check / Cleaning				☑	
Fuel line	Check and replacement as necessary. Every 2 years (2)					

(1) Served more often under dusty and contaminated conditions

(2) Carried out in authorized service centers

### ENGINE OIL REPLACEMENT

1. Open the oil crankcase plug and filler cover and drain oil.
2. Turn back the oil crankcase plug and tighten safely.
3. Fill with recommended oil grade and check the level.
4. Close the filler cover.

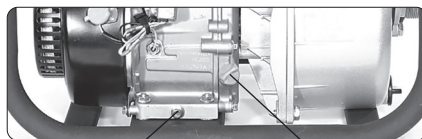

Oil crankcase plug

Oil filler cover

Fig. 11



**IMPORTANT!**



**The oil is drained fast and completely when the engine is stopped but heated.**



**ATTENTION - DANGER!**



**Make sure you dispose of used oil in dedicated tightly sealed containers to specialized collection points for used oil products.**

### MAINTENANCE OF AIR FILTER

A dirty air filter restricts air flow into the carburetor, decreases engine performance and reduces pump performance. Check the air filter and clean before every start. If the air filter is damaged, replace it. When working in extremely dirty conditions, clean the filter every 10 hours, replace it every 25 hours if needed.

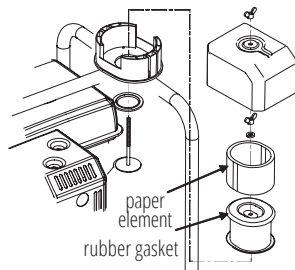

Fig. 12



**IMPORTANT!**



**Never operate engine without air filter. Air filter allows to avoid highspeed wear of motor pump engine.**

## MAINTENANCE OF SPARK PLUGS

The spark plug shall be free from snuff and must always have proper contact gap. It will enable reliable engine operation. Be careful of hot engine parts, do not touch them in order not to get burned!

1. Take out the spark plug cover.
2. Clear out the surface round the spark plug.
3. Unscrew the spark plug. Use the supplied wrench included in the tool kit.
4. Check the spark plug for damages. If the insulator is damaged or cracked, please replace spark plug. If no damages, clean spark plug with wire brush before reuse.
5. Measure the contact gap value using sample. The gap shall be equal 0,7-0,8 mm. Set the gap, if necessary, by curving electrode carefully.
6. The compression washer of spark plug shall be in good condition. If yes, the spark plug can be screwed in by hand to avoid thread damages. Tighten with wrench to press the compression washer. When installing new spark plug, please tighten it 1/4 turn. Tighten the reused spark plug 1/2-1/4 turn.



Fig. 13



Fig. 14



**IMPORTANT!**



**Please attend! The spark plug shall be tightened safely. The undertightened spark plug can overheat and become so hot that it can damage the engine.**

**Please pay attention to temperature limits of spark plugs. Do not use spark plugs which temperature limits are not right for your device.**

## TROUBLESHOOTING GUIDE

8

FAILURE	POSSIBLE CAUSE	POSSIBLE ELIMINATION
<b>Engine fails to start or is inoperative</b>	Incorrect action sequence	Keep directions of this Operation Manual
	Improper carburetor adjustment	Call the service center
	Defective spark plug	Clean, set adequate gap or replace plug
	Dirty fuel filter	Replace
<b>Engine is starting but has a low power level</b>	Irregular throttle valve position	Move to OPEN
	Contamination of spark plug cap	Clean or replace
	Air filter contamination	Clean
	Improper carburetor adjustment	Call the service center
<b>Instable engine operation</b>	Improper adjustment. Defective spark plug.	Call the service center
<b>Engine has a low power level under load</b>		
<b>Engine is running out of time</b>	Defective spark plug	Clean, set gap or replace plug
<b>High smoke content</b>	Improper carburetor adjustment	Call the service center

Before moving or transporting the motor pump ensure that ignition switch ON/OFF and fuel valve are set at (Off). Add fuel. Install the pump horizontally to avoid spilling fuel residues. Set motor pump level in order not to spill the fuel. Gasoline vapor or spilled gasoline are inflammable and explosive!



**The contact with exhaust system details or touch to the hot engine can cause bad burn or ignition. Before moving, transporting or keeping the motor pump let its engine cool.**

**KEEPING**

1. Wash pump before stopping.
2. Close the fuel valve (B). Let the engine to elaborate gasoline from carburetor. Wait until engine stops itself. Or release the screw (C), drain gasoline to the appropriate container.
3. Drain the remaining water through the cap (Fig. 15).

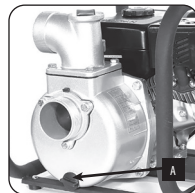

Fig. 15

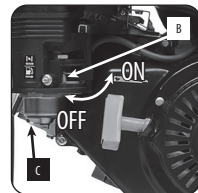

Fig. 16



**IMPORTANT!**

**The motor pump must always be ready for operation. Therefore, in the event of faults in the device, they must be rectified before installing the pump for storage.**

The motor pump which shelf life is over as well as equipment and packing shall be given for eco-friendly utilization and recycling. Do not throw out the motor pump into household wastes!

**TERMS AND CONDITIONS:**

The international manufacturer warranty is 1 year. The warranty period starts from the date of purchase. In cases when warranty period is longer than 1 year according to local legislation please contact your local dealer. The Seller which sells the product is responsible for granting the warranty. Please contact the Seller for warranty. Within the warranty period, if the product fails because of defects in the production process, it will be exchanged on the same product or repaired.

The warranty card should be kept throughout the warranty period. In case of warranty card loss, a second one will not be provided. The customer must provide the warranty card and buyer`s check during request for repair or exchange. Otherwise, the warranty service will not be provided. The warranty card, attached to the product during sale, should be correctly and fully completed by the retailer and customer, signed and stamped. In other cases, warranty is not considered as valid.

Provide clean product to the service center. Parts, that must be replaced, are the property of the service center.

**WARRANTY EXCLUSIONS:**

- If the user has failed to comply with the instructions in this manual.
- If the product features damaged or missing identification stickers or labels, serial numbers, etc.
- If product malfunction was due to improper transportation, storage and maintenance.
- In case of mechanical damages (cracks, chips, impact and fall marks, deformation of housing, power cord, plug or any other components), including those resulting from the freezing of water (ice formation), provided there are foreign objects inside the unit.

- If the product has been improperly installed and connected to the mains supply or misused.
- If the claimed malfunction cannot be diagnosed or demonstrated.
- If proper operation of the product can be restored following cleaning from dust and dirt, appropriate adjustment, maintenance, oil change, etc.
- If the product is used for business related purposes.
- If faults are detected, which have been caused by product overload. Signs of overload are molten or discolored parts as a result of high temperatures, damaged cylinder or piston surfaces, degraded piston rings or connecting rod bushes.
- The warranty does not cover the failure of the product automatic voltage regulator due to careless handling or mishandling.
- If faults are detected, which have been caused by instability of the user's power grid.
- If there are faults caused by contamination or fouling such as contamination of the fuel, oil or cooling system.
- If electrical cables or plugs show signs of mechanical or thermal damage.
- In the event of foreign liquids and objects, metal chips, etc. inside the product.
- If the malfunction is caused by the use of non-original spare parts and materials, oils, etc.
- If there are two or more faulty units that are not interconnected.
- If the damage was caused by natural factors such as dirt, dust, humidity, high or low temperature, natural disasters.
- To quick-wear parts and components (spark plugs, nozzles, pulleys, filter and safety elements, batteries, removable devices, belts, rubber seals, clutch springs, axles, manual starters, oils, gear).
- To preventive maintenance (cleaning, greasing, washing), installation and adjustment.
- If the product was tampered with, independently repaired or modified.
- In case of malfunctions resulting from normal wear and tear as a result of longterm use (end of life).
- If product operation was not stopped and continued after detecting a malfunction.
- Batteries supplied with equipment are covered by a warranty of three months.



# EC Declaration of Conformity

Nr. 082

The following products have been tested by us with the listed standards and found in compliance with the European Community Machinery Directive 2006/42/EC.

Manufacturer: DIMAX INTERNATIONAL GmbH  
Address: Hauptstr. 134, 51143 Cologne, Germany  
Product: Water pumps "Könner & Söhnen"  
Type / Model: KS 50, KS 80, KS 80TW, KS 50HP, KS 80CW, KS 80MW

The statement is based on a single evaluation of above mentioned products. It does not imply an assessment of the whole production and does not permit the use of the test lab. logo. The manufacturer should ensure that all product in series production are in conformity with the product sample detailed in this report. The applicant should hold the whole technical report at disposal of the competent all the right.

Applied EC Directives: 2006/42/EC Machinery Directive  
(EU) 2016/1628 Non-Road mobile machinery emissions

Gasoline engines KS 200, KS 250, KS 280 correspond to European Emission Standard Euro V. This is confirmed by EU TYPE-APPROVAL CERTIFICATE issued by department of transport of Luxembourg, L-2938.

Technical service responsible for carrying out the test -TÜV Rheinland Luxemburg GmbH.  
Date of issue 09/10/2018

## 2000/14/EC\_2005/88/EC Annex VI

For Models: KS 50, KS80, KS 80TW, KS 50HP, KS 80CW, KS 80MW  
Noise: measured  $L_{WA} = 100.9$  dB (A), guaranteed  $L_{WA} = 104$  dB (A)



**Issued Date:** 2020-11-10  
**Place of issue:** Warsaw city  
**Technical expert:** Homenco A.

DIMAX  
International  
GmbH  
Steuer-Nr.: 103 5722 2493  
USt-Id-Nr.: DE296177274

We DIMAX INTERNATIONAL GmbH hereby declare that specified above conforms covering European Parliament and Council Directives, 2006/42/EC of 17 May 2006 Machinery Directive. The CE mark above can be used under the responsibility of manufacturer. After completion of an EC declaration of Conformity and compliance with all relevant EC directives.

## CONTACTS

### Deutschland:

DIMAX International GmbH  
Deutschland, Hauptstr. 134,  
51143 Köln,

[www.ks-power.de](http://www.ks-power.de)

### Ihre Bestellungen

[orders@dimaxgroup.de](mailto:orders@dimaxgroup.de)

### Kundendienst, technische Fragen und Unterstützung

[support@dimaxgroup.de](mailto:support@dimaxgroup.de)

### Garantie, Reparatur und Service

[service@dimaxgroup.de](mailto:service@dimaxgroup.de)

### Sonstiges

[info@dimaxgroup.de](mailto:info@dimaxgroup.de)

---

### Polska:

DIMAX International  
Poland Sp.z o.o.

Polen, Warczawska, 306B  
05-082 Stare Babice,

[www.ks-power.pl](http://www.ks-power.pl)

[info.pl@dimaxgroup.de](mailto:info.pl@dimaxgroup.de)

---

### Україна:

ТОВ «Техно Трейд КС»,  
вул. Електротехнічна 47,  
02222, м. Київ, Україна

[www.ks-power.com.ua](http://www.ks-power.com.ua)

[sales@ks-power.com.ua](mailto:sales@ks-power.com.ua)

---