

Please, read this manual
carefully before use!

Owner's Manual



Portable power station

- KS 300PS
- KS 500PS
- KS 1200PS
- KS 2400PS

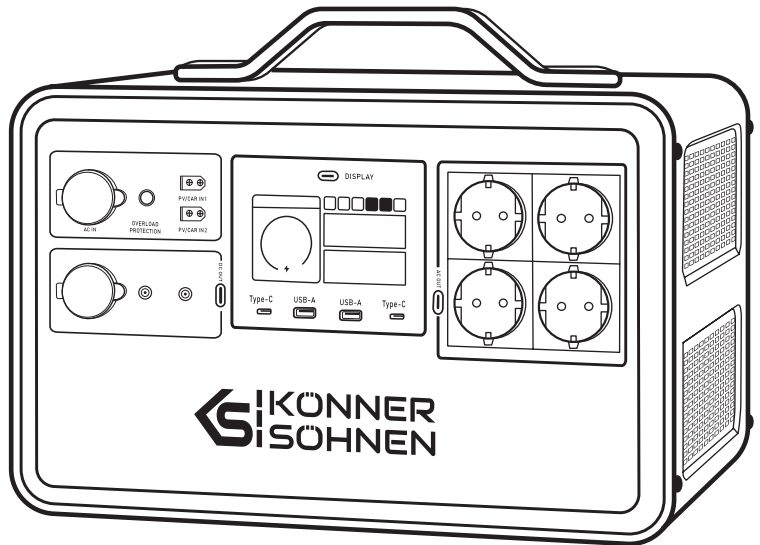



Thank you for opting for **Könnér & Söhnen®** products. This manual contains a brief description of safety, setup and use. More information can be found on the official importer's website in the support section: **konner-sohnen.com/manuals**

You can also go to the support section and download the manual by scanning the QR code or on the website of the official importer of **Könnér & Söhnen®** at **www.konner-sohnen.com**



Please, read this manual carefully before use!

The manufacturer of **Könnér & Söhnen®** products reserves the right to make changes that may not be reflected in this manual, namely:

- The manufacturer reserves the right to make changes in the product design, configuration and construction.
- The images and drawings in this manual are for reference only and may differ from the actual components and inscriptions on the products.

Contact information that you are free to use in case of any problems can be found at the end of this manual. All information in this manual is correct to the best of our knowledge and belief at the date of its publication. The current list of service centers can be found on the official importer's website at **www.konner-sohnen.com**



ATTENTION – DANGER!



Failure to follow the recommendations marked with this sign may lead to serious injury or death of the operator or third parties.



IMPORTANT!



Useful information while operating the machine.

SECURITY AND MAINTENANCE

1

1. Do not short-circuit the unit. To avoid short-circuiting, keep the unit away from all metal objects (e.g. coins, hair-pins, keys, etc.)
2. Do not heat the unit. Keep it away from high temperatures. Do not expose the unit to direct sunlight.
3. Keep away from high humidity, dusty places.
4. Do not disassemble the device or tamper with its housing.
5. Do not drop, place heavy objects on, or allow strong impact to this unit.
6. Children should be supervised to ensure that they do not play with the appliance.
7. Do not cover the device with towels, clothing or other items.
8. The unit may get hot during charging. This is normal. Be careful when handling.
9. Do not overcharge the unit.
10. Disconnect the unit when it is fully charged.
11. Power station is equipped with a lithium battery. Do not throw it out into household waste. Dispose it in special places, according to the laws in your country.
12. The product is only used for emergency, it cannot replace the standard DC or AC power of household appliances or digital products.

HOW TO USE IT:

1. Press the switch next to each port you will use.
2. When the indicator light next to the port is on, the output is turned on, and your device can be charged.
3. Press ON/OFF button to turn off output.
4. If the product is not used for a long time, it should be recharged every three months. It is better to keep the power at 60%-80% and store it in a cool and dry place.



WARNING!



If the AC port is not in use, please turn it off to save power.

MAIN OVERVIEW

MODELS KS 300PS, KS 500PS

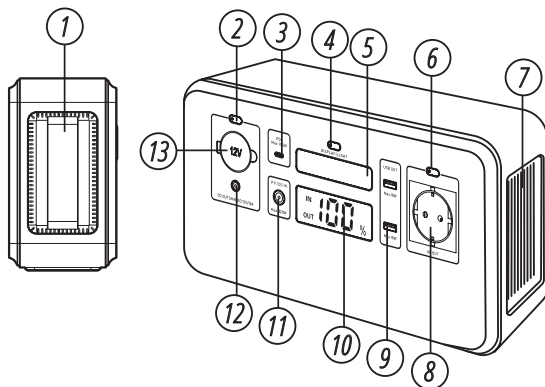

1. Handle
2. DC Output ON/OFF
3. PD TYPE-C Input/Output
4. Display/Light Switch
5. LED Light
6. AC Output ON/OFF
7. Cooling fan
8. AC Output
9. 2xUSB QC 3.0 Outputs
10. LED display
11. DC Input
12. DC Output
13. DC 12V car Port Output

THE PACKAGE INCLUDES:

1. External AC 220V charging adapter
2. DC 12V car charging cable

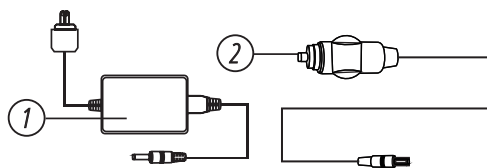

IMPORTANT!



Manufacturer reserves the right to make changes and/or improvements in design, components set and technical attributes without notice and without incurring obligation. The pictures in this manual are schematical and may not match the parameters of original product.

MODEL KS 1200PS

1. Overload protection
2. LED display
3. LED display switch
4. Handle
5. Cooling fan
6. 2xAC Outputs
7. 2xUSB-A QC 3.0 Outputs
8. 2xType-C PD(100W) Outputs
9. DC Outputs
10. DC 12V car Port Output
11. XT60 Input
12. AC Input

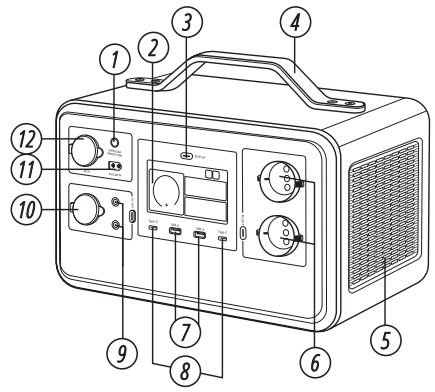

MODEL KS 2400PS

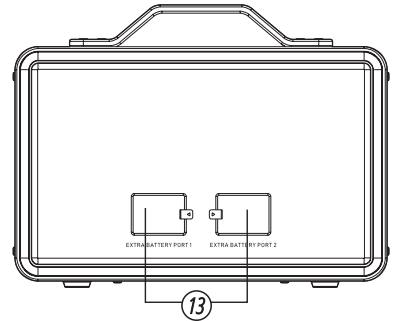
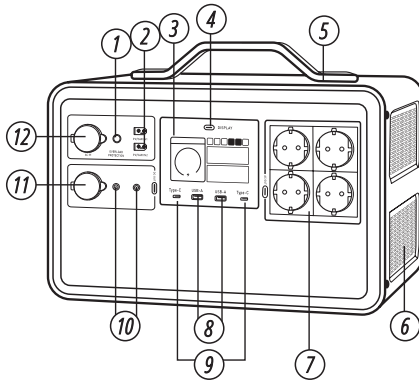

- | | |
|---|--|
| <ol style="list-style-type: none"> 1. Overload protection 2. XT60 inputs 3. LED display 4. LED display switch 5. Handle 6. Cooling fan 7. 4xAC Outputs | <ol style="list-style-type: none"> 8. 2xUSB-A QC 3.0 Outputs 9. 2xType-C PD(100W) Outputs 10. DC 12V Outputs 11. DC 12V car Port Output 12. AC Input 13. Extra battery ports
(Extra battery need to buy separately). |
|---|--|

THE PACKAGE INCLUDES:

1. AC 220V mains charging cable
2. DC 12V car charging cable

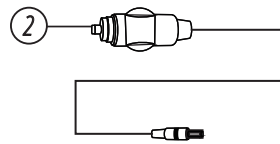
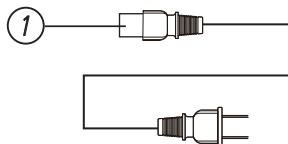

Model	KS 300PS	KS 500PS	KS 1200PS	KS 2400PS	
Battery	Capacity	294Wh	448Wh	1030Wh	2240Wh
	Cell type	LifePO4 Batteries			
	Cell capacity	23Ah	35Ah	23Ah	50Ah
	Cell Qty	4 pcs.	4 pcs.	14 pcs.	14 pcs.
	Single cell voltage	3.2V	3.2V	3.2V	3.2V
	Lifecycle	4000 cycles \geq 80%			
AC Output	AC socket	230V/50 Hz		2 \times 230V/50 Hz	4 \times 230V/50 Hz
	Rated power	300W	500W	1200W	2400W
	Peak power	500W (20mc)	1000W (20mc)	2400W (20mc)	4800W (20mc)
	Conversion efficiency	\geq 92%	\geq 92%	\geq 92%	\geq 92%
DC output	Type-C port	Type-C1: PD100W		Type-C1: PD100W, Type-C2: PD45W	
	USB-A port	2 \times USB-A QC 3.0 18W			
	Car cigarette lighter	12V/10A	12V/10A	12V/10A	12V/10A
	DC-5525 port	12V/10A	12V/10A	2 \times 12V/10A	2 \times 12V/10A
Input	0 to 100% charging with adapter via DC7909	100W Adapter 20V/5A	100W Adapter 20V/5A	-	-
	0 to 100% charging from AC outlet	-	-	1000Wh around 2 h full charge	2000Wh around 2 h full charge-
	Charging with MPPT PV module	DC 7909 120W max	DC 7909 120W max	XT60 800W max	XT60 2 \times 500W max
	XT60 charging	-	-	12-59V 800W max	2 \times 12-59V 500W max
Extra battery port	-	-	-	2 pcs.	
LED Flashlight	+	+	-	-	
Bluetooth	Bluetooth 5.0				
Application management	+	+	+	+	
Net dimensions (LxWxH)	340 \times 105 \times 185 mm	340 \times 105 \times 185 mm	340 \times 220 \times 254 mm	409 \times 299 \times 307 mm	
Weight	4.3 kg	4.9 kg	12.4 kg	25.9 kg	
Storage Temp	-10 °C + 45 °C				
Working Temp	-10 °C + 40 °C				
Charging Temp	0 °C + 40 °C				

The LED screen of this product displays the product usage status. When the product is fully charged, the LED screen turns off and stops charging. When any function is activated, the screen will light up. When the screen display is not needed, you can press the button to turn off the LED screen.

FOR MODELS KS 300PS, KS 500PS

Short press to control LED display ON/OFF.
Long press (2s.) controls LED light ON/OFF.

1. Power input indicator
2. Battery status indicator
3. Bluetooth indicator
4. Power output indicator

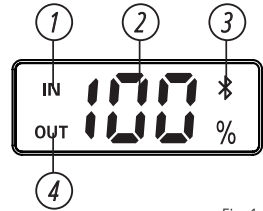
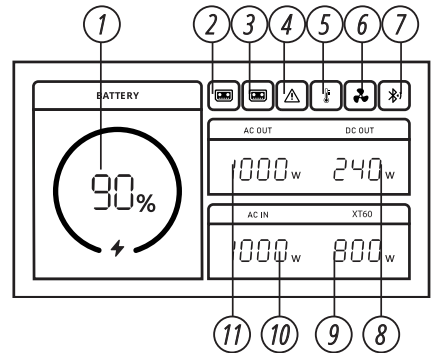
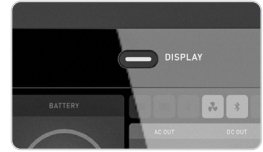

Fig. 1

FOR MODELS KS 1200PS, KS 2400PS

Short press to control LED display ON/OFF (Fig.1).
Long press (2s.) clear the BT (Bluetooth) bind list (Fig.1).

1. Battery status indicator
2. Optional battery indicator (for KS 2400PS)
3. Optional battery indicator (for KS 2400PS)
4. Overload indicator
5. Temperature alarm
6. Fan identification
7. Bluetooth Status and WiFi Status display
8. DC Output Power
9. XT60 charge indicator
10. AC Charge Power
11. AC Output Power



USB OUTPUTS: SmartPhone, Smartwatch, Digital camera, E reader, Tablet, etc.



12V CAR CIGARETTE LIGHTER: Light, Car Adaptor, etc.



AC OUTPUT: Laptop, LED screen, Household appliances, etc.

Before using or storing the product, please charge it with the charger. When connected to the mains for charging, the indicator light of the charger is on, and the LED screen will display the current charging status. When the LED screen shows that the power is 100%, it means full.

FOR MODELS KS 300PS, KS 500PS

You can charge the power station via car charger cable, which is in a set, with a help of PD adapter (not included in a set) form the mains, with a help of AC power adapter (included in a set) or by connecting solar pannel (not included in a set).

FOR MODELS KS 1200PS, KS 2400PS

You can charge the power station via AC charger cable or car charger cable, both of which are in a set, or by connecting to solar panel (not included in a set)

APP INSTRUCTIONS 8

FOR MODELS KS 300PS, KS 500PS

This software could be operated on mobile phones with Android 6.0 and IOS12.0 or above.



1. Scan the code, download the APP.
2. Turn on the permission of the mobile device:
 - for Android, turn on the Bluetooth and location permission:
 - for IOS system, turn on the Bluetooth
3. Open the APP and choose the device as shown in Fig. 1.
4. To select the device, user can turn on/off the USB port, car port and AC port (as shown in Fig. 2).

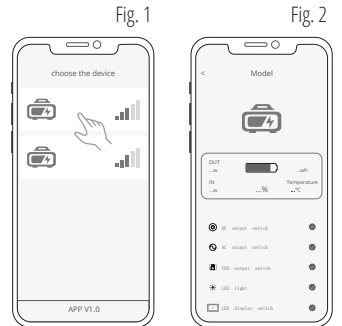

FOR MODELS KS 1200PS, KS 2400PS



This software could be operated on mobile phones with Android 6.0 and IOS12.0 or above.

1. Scan the QR code and install the opened app on your smartphone.
2. After installation, users can click the desktop icon to enter the login interface. Register and login according to the prompts on the page (Fig. 3).
3. Open Bluetooth and location sharing on your smartphone, and than log in Power Zero, select "Add Device" in the upper left corner and Click "Add via Bluetooth" (Fig. 4), add Device (Fig. 5-6).

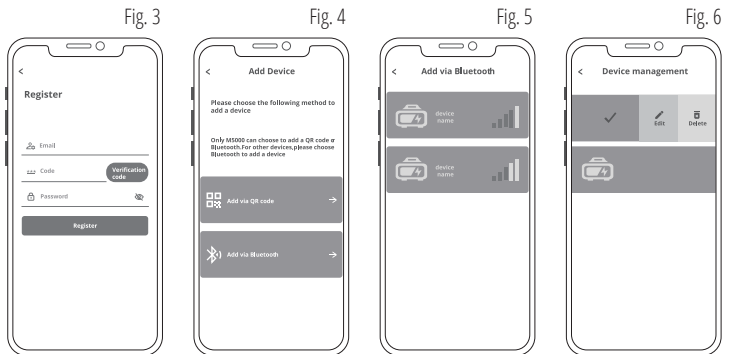

- In the device management page, click the device to enter the home page. The home page displays the real-time product status (Fig. 7).
- Select the settings wheel at the top right to change settings or get information (Fig. 8).

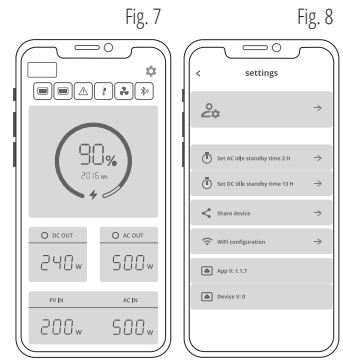

1. Can the product be taken on the aircraft?

No, according to the airline transportation standards, 100Wh and higher capacity of lithium battery can not board the aircraft.

2. How to estimate the working time of the product?

The LED display of this product can help you better understand the working status of the power supply.

When the IN (input terminal) in the screen is on: it means the product is charging.

When the OUT (output terminal) in the screen is on: it means the product is in the discharging state.

You can recognize the remaining working time of the product by the battery percentage on the display.

FAULT DIAGNOSIS

9

If your device is not successfully charged with this product, please follow the steps below:

1. Ensure that the output port is open, LED indicator lights on the power button.
2. Check the LED power display, if it is 20% or less, please charge the product.
3. The power of the device you are using exceeds the nominal power of the port of the product.
4. The device link cable you are using is not plugged in well or has poor contact.

AC ADAPTER:

The product must be charged with the AC adapter specified by us. Manufacturer is not responsible for any consequences caused by charging with other adapters.

WARRANTY SERVICE TERMS

10

The international manufacturer warranty is 1 year. The warranty period starts from the date of purchase. In cases when warranty period is longer than 1 year according to local legislation please contact your local dealer. The Seller which sells the product is responsible for granting the warranty. Please contact the Seller for warranty. Within the warranty period, if the product fails because of defects in the production process, it will be exchanged on the same product or repaired.

All faults caused by the manufacturer during the warranty period will be eliminated free of charge. Warranty repair is carried out only if you have a fully completed warranty card, the Buyer's signature of acceptance of the warranty terms, as well as a document supporting the purchase (cash receipt, sales slip or invoice). In the absence thereof, as well as in the event of errors or corrections not authenticated by the seller's seal or illegible inscriptions in the warranty card or tear-off coupon, no warranty repair is carried out, no objections to quality are accepted and the warranty card is withdrawn by the service center as invalid. The device is accepted for repair clean and full.



EC Declaration of Conformity

Nr. 167

The following products have been tested by us with the listed standards and found in compliance with EU Energy-related Products (ErP) directive Commission Regulation (EU) 2019/1782, EC Council Directive 2014/53/EU of Radio Equipment, Electromagnetic compatibility Directive (EMC) 2014/30/EC.

Manufacturer: DIMAX INTERNATIONAL GmbH
Address: Flinger Broich 203, 40235 Duesseldorf, Germany
Product: Portable power station "Könner & Söhnen"
Type / Model: KS 300PS, KS 500PS, KS 1200PS, KS 2400PS

The statement is based on a single evaluation of above mentioned products. It does not imply an assessment of the whole production and does not permit the use of the test lab. logo. The manufacturer should ensure that all product in series production are in conformity with the product sample detailed in this report. The applicant should hold the whole technical report at disposal of the competent all the right.

Applied EC Directives: 2014/30/EC Electromagnetic compatibility Directive (EMC) Directive 2011/65/EU (RoHS) as last amended by Directive (EU) 2015/863
2014/53/EU EC Council Directive of Radio Equipment

Applied Standards: EN IEC 62368-1:2020+A11
(Audio/video, information and communication technology equipment – Part 1: Safety requirements)
EN 301489-1 V 2.2.3:2019
EN 301489-17 V 3.2.4:2020
EN 300328 V 2.2.2:2019
EN 55032:2015+A11+A1
EN 55035:2017+A11
EN IEC 62368-1:2020+A11
EN IEC 62311:2020



Issued Date: 2023-11-10
Place of issue: Duesseldorf
Director: Fomin P.

DIMAX
International GmbH
Flinger Broich 203 40235 Düsseldorf
USt-ID DE296177274
koenner-soehnen.com

P. Fomin

We DIMAX INTERNATIONAL GmbH hereby declare that specified above conforms covering European Parliament and Council Directives, 2014/53/EC of 16 April 2014 Radio Equipment Directive, Electromagnetic compatibility Directive (EMC) 2014/30/EC of 26 February 2014. The CE mark above can be used under the responsibility of manufacturer. After completion of an EC declaration of Conformity and compliance with all relevant EC directives.

CONTACTS

Deutschland:

DIMAX International GmbH
Flinger Broich 203 -FortunaPark-
40235 Düsseldorf, Deutschland
www.koenner-soehnen.com

Ihre Bestellungen

orders@dimaxgroup.de

Kundendienst, technische Fragen und Unterstützung

support@dimaxgroup.de

Garantie, Reparatur und Service

service@dimaxgroup.de

Sonstiges

info@dimaxgroup.de

Polska:

DIMAX International
Poland Sp.z o.o.

Polska, Warczawska,
306B 05-082 Stare Babice,
info.pl@dimaxgroup.de

Україна:

ТОВ «Техно Трейд КС»,
вул. Електротехнічна 47, 02222,
м. Київ, Україна
sales@ks-power.com.ua
