

Please, read this manual  
carefully before use!

Owner's Manual



## Portable solar power station

KS 2000PS

KS 3000PS

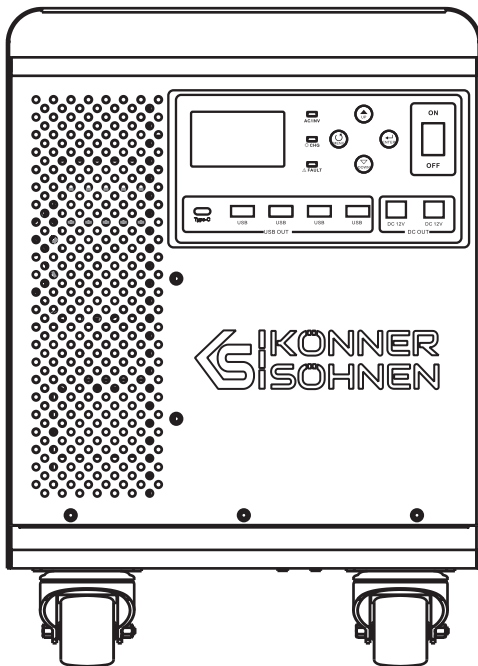



Thank you for opting for **Könnner & Söhnen®** products. This manual contains a brief description of safety, setup and use. More information can be found on the official importer's website in the support section: [konner-sohnen.com/manuals](http://konner-sohnen.com/manuals). You can also go to the support section and download the manual by scanning the QR code or on the website of the official importer of **Könnner & Söhnen®** at [www.konner-sohnen.com](http://www.konner-sohnen.com).



*Please, read this manual carefully before use!*

The manufacturer of **Könnner & Söhnen®** products reserves the right to make changes that may not be reflected in this manual, namely:

- The manufacturer reserves the right to make changes in the product design, configuration and construction.
- The images and drawings in this manual are for reference only and may differ from the actual components and inscriptions on the products.

Contact information that you are free to use in case of any problems can be found at the end of this manual. All information in this manual is correct to the best of our knowledge and belief at the date of its publication. The current list of service centers can be found on the official importer's website at [www.konner-sohnen.com](http://www.konner-sohnen.com).



**ATTENTION - DANGER!**



**Failure to follow the recommendations marked with this sign may lead to serious injury or death of the operator or third parties.**



**IMPORTANT!**



**Useful information while operating the machine.**

## PRODUCT DESCRIPTION

1

This product is a multi-function power station that combines a storage battery, MPPT solar charge controller, high frequency pure sine wave inverter and uninterruptible power supply system, and is suitable for emergency power supply or mobile use;

Thanks to the advanced MPPT solar charge controller and intelligent management of the built-in battery, the power station ensures maximum electricity production;

The built-in inverter generates "pure sine", has high efficiency, high power, small size and other advantages, and is easy to operate;

The whole unit has high efficiency and low static load losses, as well as high productivity and high power density, which is important for a mobile system.

## SAFETY INFORMATION

2

- Before using this unit, please read all instructions and precautions on this unit, understand all relevant chapters in this manual to prevent explosion which may lead to personal injury and battery damage.
- Do not disassemble the unit. When service or repair is required, send it to a professional service center. Incorrect assembly may result in electric shock or fire.
- To reduce the risk of electric shock, disconnect all wiring before attempting any maintenance or cleaning. Turning off the device does not reduce this risk.

## FEATURES

- Pure sine Wave AC Output Inverter with 2 – 3 kW rated power and power factor 1.
- High performance with small dimensions, transport wheels for high mobility.
- Setting input voltage and voltage range on the LCD Screen.
- 5V USB and 12V DC output supported.
- AC/PV input and battery priority level configurable on LCD. Protection functions such as overload, over temperature and short circuit.

## BASIC SYSTEM STRUCTURE

3

### PUBLIC POWER GRID, GENERATOR AND SOLAR PANELS AS A POSSIBLE ENERGY SOURCE

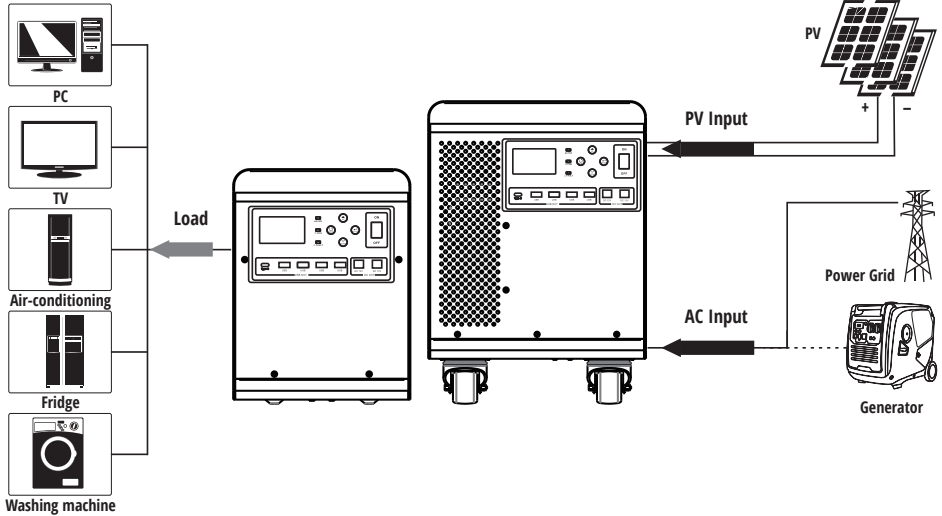

## MAIN OVERVIEW

4

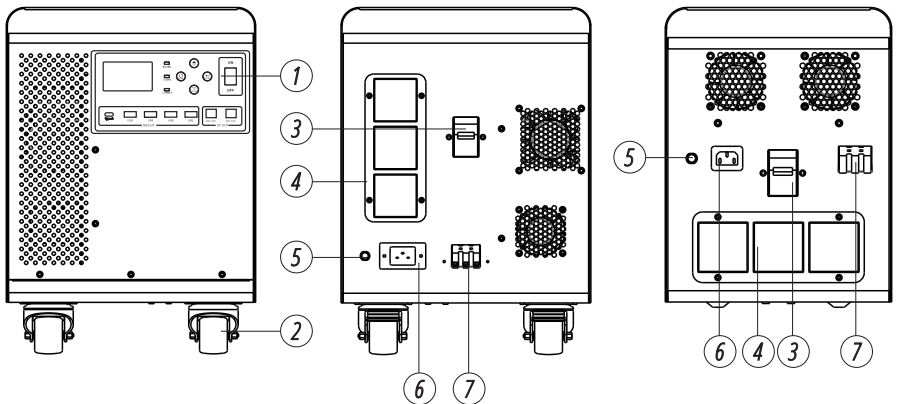

1. Control panel
2. Transport wheels
3. Battery switch
4. AC Output

5. AC Input over-current protection
6. AC Input
7. PV Input

1. LCD display
2. Function Button
3. Switch
4. DC 12V Output
5. DC 5V USB Output
6. Indicator light
7. Charge/discharge Indicator
8. Status Indicator

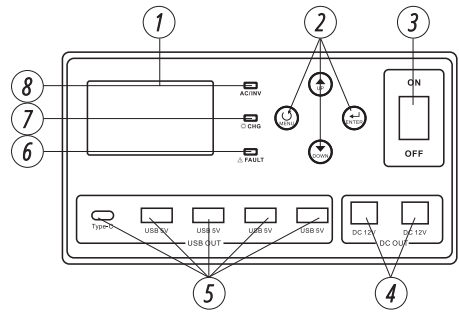

**THE PACKAGE INCLUDES:**

Make sure nothing in the package damages the product.

- Machine
- User Manual
- Mains input line



**IMPORTANT!**



Manufacturer reserves the right to make changes and/or improvements in design, components set and technical attributes without notice and without incurring obligation. The pictures in this manual are schematical and may not match the parameters of original product.

**TECHNICAL SPECIFICATION**

**5**

Model		KS 2000PS	KS 3000PS
<b>INVERTER</b>	<b>Rated Power, W</b>	2000	3000
	<b>The shape of the output</b>	Pure Sine Wave	
	<b>AC Voltage Output, V</b>	230 V	
	<b>Nominal battery voltage, V</b>	25.6 (DC)	
	<b>Efficiency</b>	90%	
<b>PV INPUT</b>	<b>Maximum current, A</b>	60	
	<b>Efficiency of the MPPT converter</b>	98% max	
	<b>Maximum idle voltage from solar panels, V</b>	145 (DC)	145 (DC)
	<b>MPPT voltage range from solar panels, V</b>	30-120 (DC)	30-120 (DC)
<b>AC INPUT</b>	<b>Rated Input Voltage, V</b>	230 ± 5% (AC)	
	<b>Input Voltage Range, V</b>	90-280 (AC)	
	<b>Frequency Range, Hz</b>	50	
	<b>Transfer Time, ms</b>	10 (UPS, VDE); 20 (APL)	
	<b>AC Charge Current, A</b>	20 (±4 A)	30 (±4 A)
<b>Built-in battery</b>	<b>Battery Type</b>	LiFePO4	
	<b>Capacity</b>	75 Ah/1920 Wh	120 Ah/3072 Wh
	<b>Rated Voltage, V</b>	25.6 (DC)	
<b>DC Output</b>		+	
<b>USB Output</b>		+	
<b>Dimensions (LxWxH), mm</b>		450x370x320	570x370x445
<b>Gross/Net weight, kg</b>		32/30	38/36

Before turning on the device, please reserve a distance of more than 30 cm above the device and to the left and right to ensure for heat dissipation. To ensure the best operation, the ambient temperature should be between 0–50 °C.

### INPUT AND OUTPUT CONNECTION

1. After power on, you can directly take power from the AC output.
2. DC outputs are active even without the station being fully turned on.
3. Connect the grid and the AC input terminal with the matching wires to load the mains and charge the battery.
4. Please make sure the cable is firmly connected and do not move the machine while it is running.

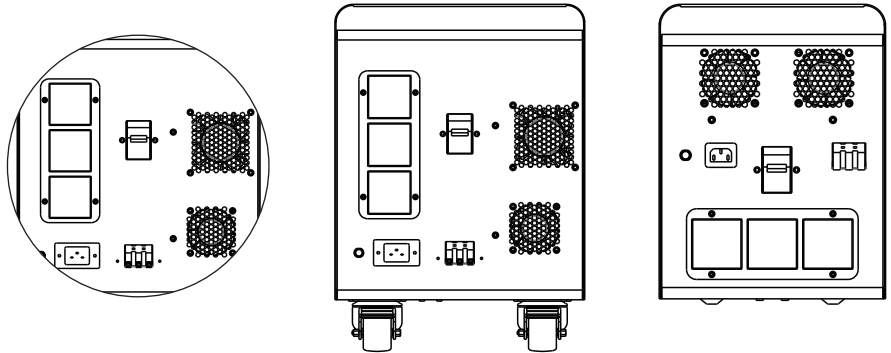

**ATTENTION - DANGER!**



**Only applicable to refractory surfaces.**

### CONNECTION OF SOLAR PANELS

Please select the appropriate wire to connect the solar panels.

#### PV MODULE SELECTION:

When choosing solar panels, be sure to consider the following parameters:

1. The open-circuit voltage (VOC) of the solar panels must not exceed the maximum open-circuit voltage of the PV input of the station.
2. The open-circuit voltage (VOC) of the solar panels must be higher than the minimum value of the PV input voltage.
3. The voltage at the point of maximum power of the PV array should be close to the optimal operating voltage of the MPPT inverter or within the range of the operating voltages of the PV input. If a solar panel does not meet this requirement, several solar panels must be connected in series to ensure compliance. See the table below.

Follow the steps below to connect the solar panels:

1. Remove the 10 mm insulating sleeves from the positive and negative leads on the PV input.
2. Check the voltage and the correct polarity of the connecting cable of the photovoltaic modules and the input connectors of the photovoltaic network. Then, connect the positive (+) side of the cable to the positive (+) side of the PV input connector. Connect the negative (-) of the cable to the negative (-) of the PV input con.

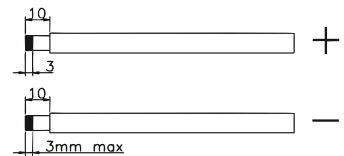

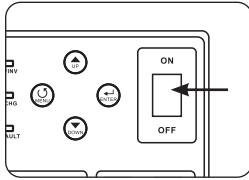

**ON/OFF**

The unit could be turned on by simply pressing the ON/OFF button (the button on the chassis).

**OPERATING AND DISPLAY PANEL**

The operation and display panel shown in the following figure is located on the front panel of the inverter. It includes three indicator lights, four function keys and an LCD. The display screen indicates the running status and input and output information.

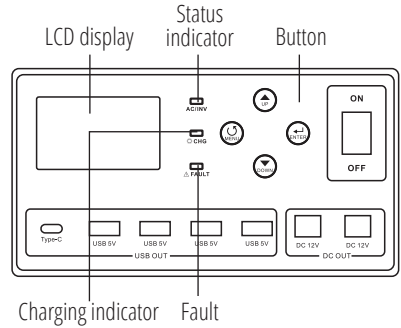

**LED INDICATOR**

LED Indicator		Messages	
AC/INV	Green	<b>Solid On</b>	Output is powered by grid in Line mode.
		<b>Flashing</b>	Output is powered by battery or PV in battery mode.
CHG	Yellow	<b>Flashing</b>	Battery is charging or discharging.
FAULT	Red	<b>Solid On</b>	Fault occurs in the inverter.
		<b>Flashing</b>	Warning condition occurs in the inverter.

**FUNCTION KEYS**

Function Keys	Description
<b>MENU</b>	Enter reset mode or setting mode, go to previous selection.
<b>UP</b>	Increase the setting data.
<b>DOWN</b>	Decrease the setting data.
<b>ENTER</b>	Enter setting mode and confirm the selection in setting mode, go to next selection or exit the reset mode.

**LCD DISPLAY ICONS**

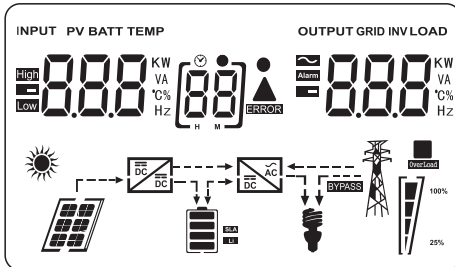

Icon	Function description	
<b>Input Source Information and Output Information</b>		
	Indicates the AC information.	
	Indicates the DC information.	
	Displays input voltage, input frequency, solar panel voltage, battery voltage and charging current. Displays output voltage, frequency, load in VA, load in W and battery discharge current.	
<b>Configuration Program and Fault Information</b>		
	Indicates the setting programs.	
	Indicates the warning and fault codes. <b>Warning:</b> flashing  with warning code. <b>Fault:</b> lighting  with fault code.	
<b>Battery Information</b>		
	Indicates the setting programs. Indicates battery level by 0-24%, 25-49%, 50-74% and 75-100% in battery mode and charging status in line mode.	
In AC mode, it will present battery charging status.		
Status	Battery voltage	LCD Display
<b>Constant Current mode/ Constant Voltage mode</b>	< 2V/cell	4 bars will flash in turns.
	2 ~ 2.083V/cell	Bottom bar will be on, and the other three bars will flash in turns.
	2.083 ~ 2.167V/cell	Bottom two bars will be on and the other two bars will flash in turns.
	> 2.167 V/cell	Bottom three bars will be on and the top bar will flash.
<b>Batteries are fully charged.</b>		4 bars will be on.
<b>In battery mode, it will present battery capacity.</b>		
Load Percentage	Battery Voltage	LCD Display
<b>Load &gt;50%</b>	< 1.717V/cell	
	1.717V/cell ~ 1.8V/cell	
	1.8 ~ 1.883V/cell	
	> 1.883 V/cell	
<b>50% &gt; Load &gt;20%</b>	< 1.817V/cell	
	1.817V/cell ~ 1.9V/cell	
	1.9 ~ 1.983V/cell	
	> 1.983V/cell	

Load Percentage	Battery Voltage	LCD Display			
Load < 20%	< 1.867V/cell				
	1.867V/cell ~ 1.95V/cell				
	1.95 ~ 2.033V/cell				
	> 2.033V/cell				
Load Information					
<b>OVERLOAD</b>	Indicates overload.				
	Indicates the load level by 0-24%, 25-49%, 50-74% and 75-100%.				
	0% ~ 24%	25% ~ 49%	50% ~ 74%	75% ~ 100%	
Mode Operation Information					
	Indicates unit connected to the mains.				
	Indicates the connection of the device to the solar panels.				
<b>BYPASS</b>	Indicates load is supplied by utility power.				
	Indicates the solar charger is working.				
	Indicates the DC/AC inverter circuit is working.				
Mute Operation					
	Indicates unit alarm is disabled.				

### LCD SETTING

After pressing and holding “ENTER” button for 2 seconds, the unit will enter setting mode. Press “UP” or “DOWN” button to select setting programs. And then, press “ENTER” or “MENU” button to confirm the selection and exit.



SETTING PROGRAMS:

Program	Description	Selectable option	
00	Exit setting mode	Escape [00] ESC	
01	Output source priority selection	[0] SBU	Solar energy provides power to the loads as first priority. If battery voltage has been higher than the setting point in program 21 for 5 minutes, the inverter will turn to battery mode, solar and battery will provide power to the load at the same time. When the battery voltage drops to the setting point in program 20, the inverter will turn to bypass mode, utility provides power to the load only, and the solar will charge the battery at the same time.
		[0] SOL	Solar energy provides power to the loads as first priority. If battery voltage has been higher than the setting point in program 21 for 5 minutes, and the solar energy has been available for 5 minutes too, the inverter will turn to battery mode, solar and battery will provide power to the load at the same time. When the battery voltage drops to the setting point in program 20, the inverter will turn to bypass mode, utility provides power to the load only, and the solar will charge the battery at the same time.
		(default) [0] UT.	Utility will provide power to the loads as first priority. Solar and battery energy will provide power to the loads only when utility power is not available.
02	AC input voltage range	Appliances (default) [02] APL	If selected, acceptable AC input voltage range will be within 90-280V AC.
		UPS [02] UPS	If selected, acceptable AC input voltage range will be within 170-280V AC.
		VDE [02] VDE	If selected, acceptable AC input voltage range will conform to VDE 4105 (184V AC-253V AC).
		GEN [02] GEN	When the user uses the device to connect the generator, select the generator mode.
03	Output voltage	[03] 230 <sup>v</sup>	Set the output voltage amplitude, (220VAC-240VAC)

Program	Description	Selectable option	
04	Output frequency	50 Hz (default) [04] 500	60 Hz [04] 600
05	Solar supply priority	[05] 6LU	Solar energy provides power to charge battery as first priority.
		(default) [05] 16U	Solar energy provides power to the loads as first priority.
06	Overload bypass: When enabled, the unit will transfer to line mode if overload occurs in battery mode.	Bypass disable [06] 6Yd	Bypass enable (default) [06] 6YE
07	Auto restart when overload occurs	Restart disable (default) [07] 1Td	Restart enable [07] 1TE
08	Auto restart when over temperature occurs	Restart disable (default) [08] 1Td	Restart enable [08] 1TE
10	Charger source priority: To configure charger source priority	If this inverter/charger is working in Line, Standby or Fault mode, charger source can be programmed as below:	
		Solar first [10] C50	Solar energy will charge battery as first priority. Utility will charge battery only when solar energy is not available.
		Solar and Utility (default) [10] 5MU	If this inverter/charger is working in Battery mode or Power saving mode, only solar energy can charge the battery. Solar energy will charge a battery if it's available and sufficient.
		Only Solar [10] 050	Solar energy will be the only source of energy regardless of the availability of power from the grid.
When the inverter/charger is in battery mode or in power saving mode, the battery is only charged by solar energy. Solar energy will charge battery if it's available and sufficient.			
11	Maximum charging current: To configure total charging current for solar and utility chargers. (Max. charging current = utility charging current + solar charging current)	[11] 60 <sup>A</sup>	Setting range is from 1A to 60A. Increment of each click is 1A.
		[11] 80 <sup>A</sup>	Setting range is from 1A to 80A. Increment of each click is 1A.

Program	Description	Selectable option	
13	Maximum utility charging current	20A (default) [13] 20	20A (Maximum current) [13] 30 <sup>A</sup>
17	Bulk charging voltage (C.V voltage)	28.8V (default) [17] CV 28.8 <sub>v</sub>	Setting range is from 24.0V to 29.2V. Increment of each click is 0.1V
18	Floating charging voltage	27.0V (default) [18] FLV 27.0 <sub>v</sub>	Setting range is from 24.0V to 29.2V. Increment of each click is 0.1 V.
19	Bulk charging voltage (C.V voltage)	22.4V (default) [19] CV 22.4 <sub>v</sub>	Setting range is from 20V to 24V. Increment of each click is 0.1 V.
20	Battery stop discharging voltage when grid is available	23V (default) [20] 23.0 <sub>v</sub>	Setting range is from 22.0V to 29.0V. Increment of each click is 0.1 V.
21	Battery stop charging voltage when grid is available	27V (default) [21] 27.0 <sub>v</sub>	Setting range is from 22.0V to 29.0V. Increment of each click is 0.1 V.
22	Auto turn page	(default) [22] PLE	If selected, the display screen will auto turn the display page.
22	Auto turn page	[22] Pld	If selected, the display screen will stay at latest screen user finally switches.
23	Backlight control	Backlight on [23] LON	Backlight off (default) [23] LOF
24	Alarm control	Alarm on (default) [24] BON	Alarm off [24] BOF
25	Beeps while primary source is interrupted	Alarm on [25] AON	Alarm off (default) [25] AOF
27	Record Fault code	Record enable (default) [27] FON	Record disable [27] FOF

Program	Description	Selectable option	
28	Solar power balance: When enabled, solar input power will be automatically adjusted according to connected load power.	Solar power balance enable <b>[28] 5bE</b>	If this option is enabled, the input power of the solar cell will be automatically adjusted according to the following formula: Max. input power of solar energy, max. battery charging power + connected load power when the device is in offline mode.
		Solar power balance disable (default) <b>[28] 5bd</b>	If selected, the solar input power will be the same to max. Battery charging power no matter how many loads are connected. The max. battery charging power will be based on the setting current in program 11 (Max. solar power, Max. battery charging power)
29	Power saving mode enable/disable	Saving mode disable (default) <b>[29] 5d5</b>	If disable, no matter connected load is low or high, the on/off status of inverter output will not be effected.
		Saving mode enable <b>[29] 5e7</b>	If enable, the output of inverter will be off when connected load is pretty low or not detected.
30	Battery equalization	Battery equalization <b>[30] Ee7</b>	Battery equalization disable (default) <b>[30] Ed5</b>
31	Battery equalization voltage	28.8V (default) <b>[17] C4 28.8</b>	Setting range is from 24.0V to 29.2V. Increment of each click is 0.1V
33	Battery equalization time	60 min (default) <b>[33] 60</b>	Setting range is from 5 min to 900 min. Increment of each click is 5 min.
34	Battery equalization timeout	120 min (default) <b>[34] 120</b>	Setting range is from 5 min to 900 min. Increment of each click is 5 min.
35	Equalization interval	30 days (default) <b>[35] 30d</b>	Setting range is from 0 to 900 days. Increment of each click is 1 day.
36	Equalization activated immediately	Enable <b>[36] Ae7</b>	<b>[36] Ad5</b>











Program	Description	Selectable option
36	Equalization activated immediately	If equalization function is enabled in program 30, this program can be set up. If "Enable" is selected in this program, it's to activate battery equalization immediately and LCD main page will shows "EQ". If "Disable" is selected, it will cancel equalization function until next activated equalization time arrives based on program 35 setting. At this time "EQ" will be shown in LCD main page too.

After pressing and holding "MENU" button for 6 seconds, the unit will enter reset model. Press "Up" and "DOWN" button to select programs. And then, press "ENTER" button to exit.

SET	(default) [dt] ntl	Reset setting disable.
	[dt] t-5t	Reset setting disable.

## FAULT REFERENCE CODE

8

Fault Code	Fault Event	Icon on
01	Fan is locked when inverter is off.	[01] 
02	Inverter transformer over temperature.	[02] 
03	Battery voltage is too high.	[03] 
04	Battery voltage is too low.	[04] 
05	Output short-circuited.	[05] 
06	Inverter output voltage is high.	[06] 
07	Overload time out.	[07] 
08	Inverter bus voltage is too high.	[08] 
09	Bus soft start failed.	[09] 
11	Main relay failed.	[11] 
21	Inverter output voltage sensor error.	[21] 

Fault Code	Fault Event	Icon on
22	Inverter grid voltage sensor error.	[22] 
23	Inverter output current sensor error.	[23] 
24	Inverter grid current sensor error.	[24] 
25	Inverter load current sensor error.	[25] 
26	Inverter overload (current) error.	[26] 
27	Inverter radiator over temperature.	[27] 
31	Solar charger battery voltage class error.	[31] 
32	Solar charger current sensor error.	[32] 
33	Solar charger current is uncontrollable.	[33] 
41	Inverter grid voltage is low.	[41] 
42	Inverter grid voltage is high.	[42] 
43	Inverter grid under frequency.	[43] 
44	Inverter grid over frequency.	[44] 
51	Inverter overcurrent protection error.	[51] 
52	Inverter bus voltage is too low.	[52] 
53	Inverter soft start failed.	[53] 
55	Over DC voltage in AC output.	[55] 
56	Battery connection is open.	[56] 
57	Inverter control current sensor error.	[57] 
58	Inverter output voltage is too low.	[58] 

Fault Code	Fault Event	Icon on
61	Fan is locked when inverter is on.	[61]
62	Fan 2 is locked when inverter is on.	[62]
63	Battery is over-charged.	[63]
64	Low battery.	[64]
67	Overload.	[67]
70	Output power derating.	[70]

**WARNING INDICATOR**

Fault Code	Fault Event	Icon on
72	Solar charger stops due to low battery.	[72]
73	Solar charger stops due to high PV voltage.	[73]
74	Solar charger stops due to over load.	[74]
75	The solar charging module has overheated.	[75]
76	PV charger communication error.	[76]
77	Parameter error.	[77]

**OPERATING STATE DESCRIPTION**

9

Operation state	Description	LCD display
<b>Utility-Tie state</b>	PV energy is charger into the battery and utility provide power to the AC load.	<p>The PV input is activated</p>
<b>Charge state</b>	PV energy and grid can charge batteries.	

Operation state	Description	LCD display
<b>Bypass state</b>	Error are caused by inside circuit error or external reasons such as over temperature, output short-circuited and so on.	
<b>Off-Grid state</b>	The inverter will provide output power from battery and PV power.	Inverter power loads from PV energy 
		Inverter power loads from battery and PV energy 
<b>Off-Grid state</b>	The inverter will provide output power from battery and PV power.	
<b>Stop mode</b>	The inverter stop working if you turn off the inverter by the soft key or error has occurred in the condition of no grid.	

## DISPLAY SETTING

10

The LCD display information will be switched in turns by pressing "UP" or "DOWN" key. The selectable information is switched as below order: battery voltage, battery current, inverter voltage, inverter current, grid voltage, grid current, load in Watt, load in VA, grid frequency, inverter frequency, PV voltage, PV charging power, PV charging output voltage, PV charging current.

Selectable information	LCD display	
<b>Battery voltage/DC discharging current</b>	260 <sup>WATT</sup> V	480 A
<b>Inverter output voltage/Inverter output current</b>	229 V	6.70 <sup>INV</sup> A
<b>Grid voltage/Grid current</b>	229 V	-30 A
<b>Load in Watt/VA</b>	150 <sup>KW</sup>	168 <sup>LOAD</sup> K VA
<b>Grid frequency/Inverter frequency</b>	500 <sup>INPUT</sup> Hz	500 <sup>INV</sup> Hz
<b>Voltage and power from solar panels</b>	610 <sup>PV</sup> V	100 <sup>KW</sup>
<b>PV charger output voltage and MPPT charging current</b>	250 <sup>PV</sup> V	400 <sup>OUTPUT</sup> A





# EC Declaration of Conformity

Nr. 162

The following products have been tested by us with the listed standards and found in compliance with the European Community Electromagnetic compatibility Directive (EMC) 2014/30/EC, Low Voltage Directive 2014/35/EC.

Manufacturer: DIMAX INTERNATIONAL GmbH  
Address: Flinger Broich 203, 40235 Duesseldorf, Germany  
Product: Portable power station "Könner & Söhnen"  
Type / Model: KS 2000PS, KS 3000PS

The statement is based on a single evaluation of above mentioned products. It does not imply an assessment of the whole production and does not permit the use of the test lab. logo. The manufacturer should ensure that all product in series production are in conformity with the product sample detailed in this report. The applicant should hold the whole technical report at disposal of the competent all the right.

Applied EC Directives: 2014/30/EC Electromagnetic compatibility Directive (EMC)  
2014/35/EU Low Voltage

Applied Standards: EN 62109-1:2010  
EN 62109-2:2011  
EN IEC62109-1:2010  
EN IEC62109-1:2011  
EN IEC61000-6-1:2019  
EN IEC61000-6-3:2021



**Issued Date:** 2023-10-01  
**Place of issue:** Duesseldorf  
**General director:** Fomin P. *P. Fomin*

**DIMAX**  
International  
GmbH  
Steuer-Nr.: 103 5722 2493  
UStIdNr: DE296177274

We DIMAX INTERNATIONAL GmbH hereby declare that specified above conforms covering European Parliament and Council Directives, 2014/35/EC Low Voltage Directive of 26 February 2014, Electromagnetic compatibility Directive (EMC) 2014/30/EC of 26 February 2014. The CE mark above can be used under the responsibility of manufacturer. After completion of an EC declaration of Conformity and compliance with all relevant EC directives.

## CONTACTS

### Deutschland:

DIMAX International GmbH Flinger  
Broich 203 -FortunaPark- 40235  
Düsseldorf, Deutschland  
[www.koenner-soehnen.com](http://www.koenner-soehnen.com)

### Ihre Bestellungen

[orders@dimaxgroup.de](mailto:orders@dimaxgroup.de)

### Kundendienst, technische Fragen und Unterstützung

[support@dimaxgroup.de](mailto:support@dimaxgroup.de)

### Garantie, Reparatur und Service

[service@dimaxgroup.de](mailto:service@dimaxgroup.de)

### Sonstiges

[info@dimaxgroup.de](mailto:info@dimaxgroup.de)

---

### Polska:

DIMAX International Poland Sp.z o.o.  
Polska, Warszawska,  
306B 05-082 Stare Babice,  
[info.pl@dimaxgroup.de](mailto:info.pl@dimaxgroup.de)  
[www.koenner-sohnen.com](http://www.koenner-sohnen.com)

---

### Україна:

ТОВ «Техно Трейд КС»,  
вул. Електротехнічна 47,  
02222, м. Київ, Україна  
[sales@ks-power.com.ua](mailto:sales@ks-power.com.ua)  
[www.koenner-sohnen.com](http://www.koenner-sohnen.com)