

**Please, read this manual
carefully before use!**

Owner's Manual



Cordless chainsaw

KS CS20V-12

KS CS40V-14

KS CS40V-16

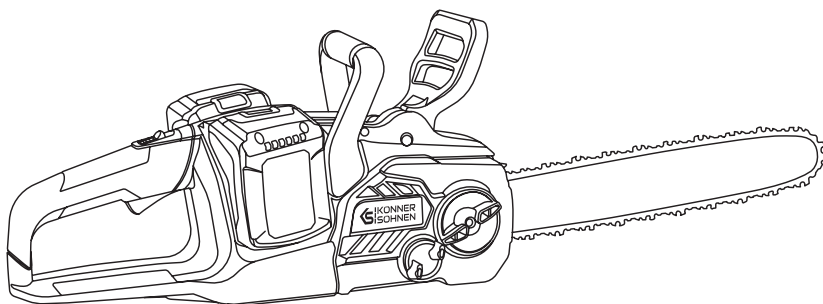



Thank you for opting for **Könner & Söhnen®** products. This manual contains a brief description of safety, setup and use. More information can be found on the official importer's website in the support section: **konner-sohnen.com/manuals**

You can also go to the support section and download the manual by scanning the QR code or on the website of the official importer of **Könner & Söhnen®** at **www.konner-sohnen.com**



*Please, read this manual
carefully before use!*

The manufacturer of **Könner & Söhnen®** products reserves the right to make changes that may not be reflected in this manual, namely:

- The manufacturer reserves the right to make changes in the product design, configuration and construction.
- The images and drawings in this manual are for reference only and may differ from the actual components and inscriptions on the products.

Contact information that you are free to use in case of any problems can be found at the end of this manual. All information in this manual is correct to the best of our knowledge and belief at the date of its publication. The current list of service centers can be found on the official importer's website at **www.konner-sohnen.com**



ATTENTION – DANGER!



Failure to follow the recommendations marked with this sign may lead to serious injury or death of the operator or third parties.



IMPORTANT!



Useful information while operating the machine.

IMPORTANT SAFETY INFORMATION

1

WORK AREA

- Keep the work area clean and well lit. Cluttered and dark areas invite accidents.
- Do not operate power tools in explosive atmospheres, such as in the presence of flammable liquids, gases or dust. Power tools create sparks, which may ignite the dust or fumes.
- Keep children or unauthorized individuals away from the work area, while working with power tools. Distractions can cause you to lose control.

ELECTRICAL SAFETY

- Do not store or use power tools in wet conditions (rain, snow). Water entering a power tool will increase the risk of electric shock.

PERSONAL SAFETY

- Do not operate tool when you are tired or under the influence of drugs, alcohol or medication.
- Use safety equipment. Always wear eye protection. Safety equipment such as dust mask, non-skid safety shoes, hard hat, or hearing protection will reduce personal injuries.
- Do not overreach. Keep proper footing and balance at all times. This enables better control of the power tool in unexpected situations.
- Do not wear loose clothing or jewellery; Keep your hair, clothing and gloves away from moving parts. Loose clothes, jewellery or long hair can be caught in moving parts.

POWER TOOL USE AND CARE

- Store idle power tools out of the reach of children.
- Maintain power tools.

SPECIFIC SAFETY RULES FOR CHAIN SAW

2



WARNING!



Do not operate your chain saw until it is completely assembled and installed according to the instructions.



ATTENTION – DANGER!



Keep hands away from blade. Contact with blade will result in serious personal injury.

- The cordless chainsaw is designed exclusively for cutting wood and should not be used for any non-wood items, such as brickwork, plastic, or food. Using the saw for any purpose other than sawing wood is not recommended and goes against its intended use
- Make sure that the area in which you are cutting is free from obstructions. Do not let the nose of the Guide bar contact a log, branch, fence, or any other obstruction while you are operating the unit.
- Do not grasp the exposed cutting blades or cutting edges when picking up or holding the product.
- Cut only when visibility and light are adequate for you to see clearly.
- To protect yourself from electrocution, do not operate within 50 feet of overhead electrical lines.
- Before starting the motor, make sure the chain is not contacting any object.
- Turn off the motor and make sure cutting attachment has stopped before setting unit down.
- Follow the sharpening and maintenance instructions for the saw chain.
- Use only the replacement guide bars and low kickback chains specified for the unit.
- Do not operate the saw with one hand! Serious injury to the operator, helpers, bystanders, or any combination of these persons may result from one hand operation. This saw is intended for two-hand use.
- Use extreme caution when cutting small-sized brush and saplings because slender material may catch the saw chain and be whipped toward you or pull you off balance.
- When cutting a limb that is under tension, be alert for spring back so that you will not be struck.
- To avoid accidental starting, never carry plugged in product with finger on switch.
- Maintain product with care. Keep cutting edge sharp and clean for best performance and to reduce the risk of injury. Follow this instruction for lubricating and changing accessories. Keep handles dry, clean, and free from oil and grease.
- Remove the battery pack when not in use, before servicing, and when changing accessories.
- Service on the product must be performed by qualified repair personal only. Service or maintenance performed by unqualified personal could result in injury to the user or damage to the product.

CAUSES AND OPERATOR PREVENTION OF KICKBACK

3



ATTENTION – DANGER!



Beware of kickback! Be careful of kickback of the machine during work. There is danger of injury here. You can avoid kickbacks by exercising caution and using a correct sawing technique.

- Kickback may occur when the nose or tip of the guide bar touches an object, or when the wood closes in and pinches the saw chain in the cut (cf. image 1/fig. B).

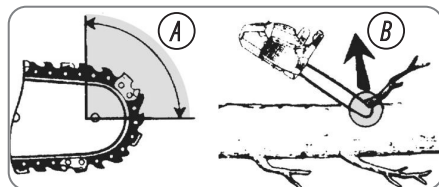

Fig. 1

- Tip contact in some cases may cause a sudden reverse reaction, kicking the guide bar up and back towards the operator (cf. image 1/fig. A).
- Pinching the saw chain along the top of the guide bar may push the guide bar rapidly back towards the operator.
- Either of these reactions may cause you to lose control of the saw which could result in serious personal injury. Do not rely exclusively upon the safety devices built into your saw. As a chain saw user, you should take several steps to keep your cutting jobs free from accident or injury.

Kickback is the result of tool misuse and/or incorrect operating procedures or conditions and can be avoided by taking proper precautions as given below:

- Maintain a firm grip, with thumbs and fingers encircling the chainsaw handles, with both hands on the saw and position your body and arm to allow you to resist kickback forces. Kickback forces can be controlled by the operator if proper precautions are taken. Do not let go of the chainsaw
- Do not overreach and do not cut above shoulder height. This helps prevent unintended tip contact and enables better control of the chainsaw in unexpected situations.
- Only use replacement bars and chains specified by the manufacturer. Incorrect replacement bars and chains may cause chain breakage and/or kickback.
- Follow the manufacturer's sharpening and maintenance instructions for the saw chain. Decreasing the depth gauge height can lead to increased kickback.

FURTHER SAFETY DIRECTIONS





4







- Comply carefully with maintenance, control and service instructions in this manual. Damaged protective devices and parts have to be repaired or changed except as noted otherwise in this manual.
- It is recommended that a first-time user at least practice the cutting of logs on a saw log or frame.
- For sawing work on hillsides, always stand in the area above the log. To keep total control while sawing through, reduce the pressure at the end of the cut without loosening your grip on the handles of the chainsaw. Make sure the saw chain does not touch the ground. After finishing the cut, wait until the chainsaw comes to a halt before removing it. Always shut off the engine of the chainsaw before switching between trees.
- Dirt, stones, loose bark, nails, clips, and wires must be removed from the tree.

SYMBOLS

5

Some of the following symbols may be used on this product. Please study them and learn their meaning. Proper interpretation of these symbols will allow you to operate the product better and safer.

	Length of the chain bar.
	Battery charge level indicator.
Graphical symbol beneath the chain sprocket:	
	Observe direction of travel of the saw chain. Caution! Read the operating instructions.
Graphical symbol on the blade:	
	Direction of travel of the saw chain.
Graphical symbol on the oil tank cap:	
	Saw chain lubrication.

Graphical symbol on the fixing screw for the chain sprocket cover:	
	OPEN
	CLOSE
Graphical symbol on the chain brake lever:	
	Chain brake: OFF
	Chainbrake: ON
Symbol on the screw for the chain quick- tensioning system:	
	Loosen.
	Tighten.

MAIN OVERVIEW **6**

MODEL KS CS20V-12

1. Guide bar
2. Saw chain
3. Chain kickback
4. Oil tank cap
5. Lock off button ring
6. Rear handle
7. Lithium battery (not included)
8. Trigger
9. Front handle
10. Toothed stop
11. Chain tensioning ring brake handle
12. Chain cover retainer
13. Oil inspection window

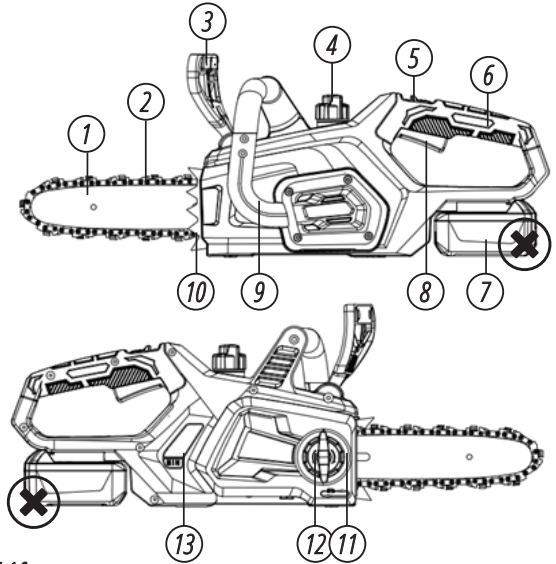

MODELS KS CS40V-14, KS CS40V-16

- | | |
|--|--|
| <ol style="list-style-type: none"> 1. Rear handle 2. ON/OFF switch 3. Switch lock 4. Front handle 5. Chain inertia brake lever/Hand protection 6. Saw chain 7. Guide rail 8. Toothed stop 9. Oil tank cover 10. Oil level indicator 11. Mounting screw for the sprocket cover | <ol style="list-style-type: none"> 12. Screw for the chainquick- ten- sioning system 13. Sprocket cover 14. Rear hand protection 15. Blade encasing 19. Coach screw 20. Chain sprocket 21. Chain tensioner pin 22. Chain tensioner pin holder 23. Guide rails for battery 24. Batterycharge level indicator 25. ON/OFF button |
|--|--|

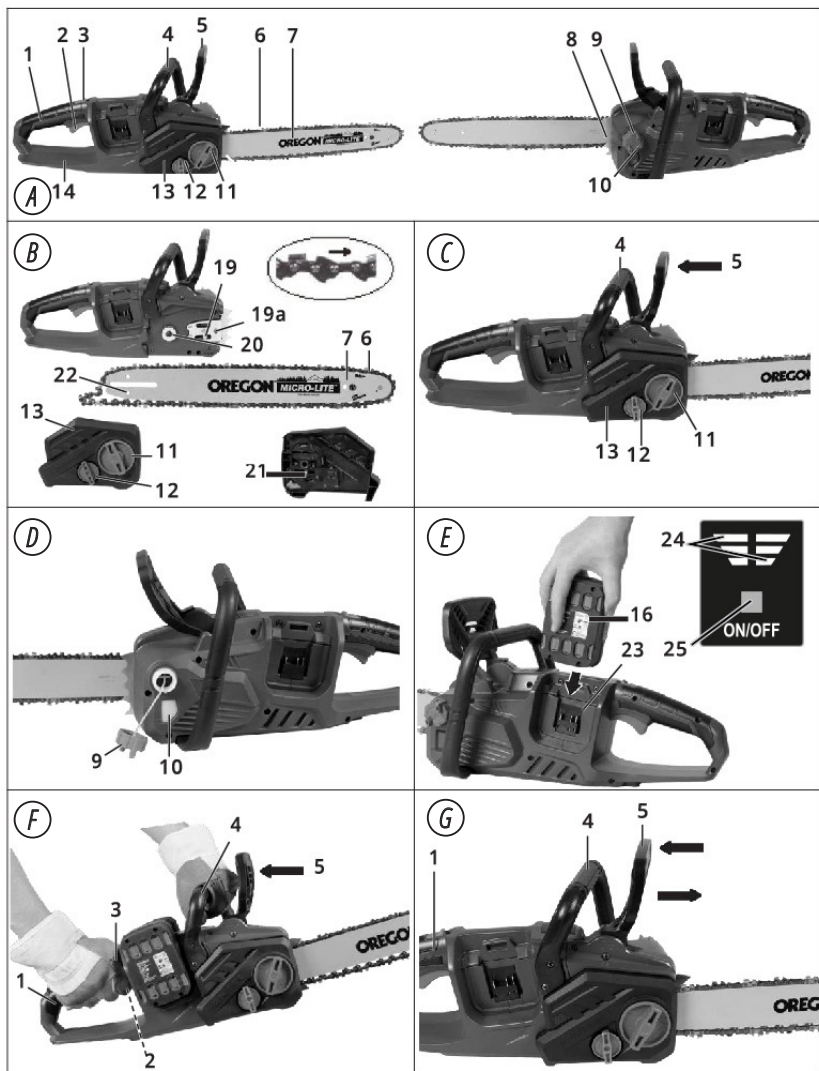

Rechargeable battery, charger, oil bottle is not included.



IMPORTANT!



Manufacturer reserves the right to make changes and/or improvements in design, components set and technical attributes without notice and without incurring obligation. The pictures in this manual are schematical and may not match the parameters of original product.

Model	KS CS20V-12	KS CS40V-14	KS CS40V-16
Rated voltage	20V	40V (20V+20V)	40V (20V+20V)
Working speed	3000 rpm	8000 rpm	8000 rpm
Chain length	12" (30 cm)	14" (35 cm)	16" (40 cm)
Motor type	Brush motor	Brushless motor	Brushless motor
Chain speed	5.6 m/s	15 m/s	15 m/s
Oil tank capacity	300 ml	250 ml	250 ml
Chain tensioning without a tool	+	+	+
Gross dimensions (L×W×H)	455×225×230 mm	455×220×255 mm	455×220×255 mm
Gross/Net weight	3.7/3.5 kg	3.9/3.7 kg	3.9/3.7 kg

INSTRUCTIONS FOR ASSEMBLY, START AND MAINTENANCE

8

- Do not attempt to modify this product or create accessories not recommended for use with this product. Any such alteration or modification is misuse and could result in a hazardous condition leading to possible serious personal injury.
- Do not connect to power supply until assembly is complete. Failure to comply could result in accidental starting and possible serious personal injury.

FITTING THE GUIDE BAR AND CHAIN

9



WARNING!





If the chain saw is already connected to the battery pack, remove the battery pack from the chain saw. Wear protective gloves whenever doing any work on the saw chain.

Before assembling the guide bar with the saw chain, check the cutting direction of the teeth! The running direction is marked with an arrow on the cover. To determine the direction of cut, it may be necessary to turn over the saw chain. Hold the guide bar vertically with the tip pointing upwards and put on the saw chain, beginning at the tip of the bar.

MODEL KS CS20V-12

1. Place the guide bar with the saw chain on the chain wheel and guide bolt. Ensure that the adjustment plate is showing to you.
2. Place the saw chain round the chain wheel and check whether it is correctly.
3. The adjustment plate is fastened to the guide rail with the screw.
4. Place the cover on top and tighten gently with the lock nut.

MODELS KS CS40V-14, KS CS40V-16

1. Lay the saw on a flat surface.
2. Turn the fastening bolt (11) anti-clockwise (), to remove the sprocket chain wheel covering (13).
3. Spread the chain (6) out into a loop with the cutting edges running clockwise. Use the graphical symbol on the blade or below the chain sprocket (20) as a guide to align the saw chain (6).  Direction of travel of the saw chain.

4. Slide the saw chain (6) into the bar guide groove. Turn the guide bar (4), raise it to an angle of approx. 45 degrees. This will make it easier to replace the saw chain (6) onto the sprocket (20).
5. Place the chain bar (7) and saw chain (6) on the bar bolts (19). When the pin (19a) to the right of the coach screw (19) sits in the slotted recess on the blade, the blade is placed correctly. It is normal that the saw chain (6) is slack.
6. Position the sprocket chain wheel cover (13). The chain tensioner pin (21) on the inside of the sprocket cover (13) must be guided into the chain tension pin holder (22).
7. Pre-tension the saw chain (6) by turning the screw for the chain quick-tensioning system (12) in clockwise direction.
8. Tighten the fastening bolt (11) ().

ADDING AND CHECK BAR AND CHAIN LUBRICANT

10

CHAIN LUBRICATION

To prevent excessive wear, the saw chain and guide bar must be evenly lubricated during operation. Lubrication is automatic. Never work without chain lubrication. It is therefore important to check both chain lubrication and the oil gauge every use (Fig. 4). Never use the saw when the oil level is below the "Min." mark. (about 5 ml of oil left). Top up with oil until the oil window is full. .

CHECKING THE AUTOMATIC

Before work, check the automatic chain lubrication and oil gauge. Switch on the chain saw and hold it above the ground. Be careful not to allow the chain saw to touch the ground. For safety reasons it is best to keep a clearance of at least 20 cm. If you now see growing traces of oil, the chain lubrication system is working correctly. If no oil trace can be seen clean the oil passages or turn the chainsaw to our Service-Center.

CHAIN LUBRICANTS

The service life depends to a large extent on the quality of the lubricant used. Old oil must not be used! To lubricate the cutting part of the saw, it is necessary to use only special adhesive oil for saw chains. Adhesive oil has increased adhesion to metal and lubricates not only the upper part of the saw bar but also the lower part.

BATTERY, CONNECTION AND REMOVAL

11

Battery is not included.

- Store the battery pack fully charged.
- Do not store the battery pack on the tool.

TO REMOVE THE BATTERY PACK

Press the battery release button, slide the battery pack backward, and then pull or lift the battery out of the tool.

TO INSTALL THE BATTERY PACK

To install the battery pack into the saw, align the rails of the battery pack with the rails in the handle and push the battery into the handle. To connect the battery, slide the battery pack fully forward. Until the latch locks into place.

Follow these instructions in order to avoid injury and to reduce the risk of electric shock or fire:

- Replace the battery pack or the charger immediately if the battery case or charger cord is damaged.
- Verify that the battery pack is removed before inspecting, adjusting, or performing maintenance on any part of the chain saw.

BATTERY CHARGE LEVEL INDICATOR

Press the ON/OFF button. The LEDs on the control panel light up.

The charge level of the batteries is indicated by illumination of the corresponding LED lights of the battery charge level indicator.

3 LEDs illuminated (red, orange and green):

Battery charged

2 LEDs illuminated (red and orange):

Battery partially charged

1 LED illuminated (red):

Battery needs to be charged



KS CS20V-12



KS CS40V

STARTING THE CHAIN SAW

12

- Install the bar and chain (see page "Replacing the bar and chain")
- Switch on the chainsaw only when chain bar, saw chain and sprocket chain wheel covering are correctly assembled.
- Make sure you have a secure stance.
- Insert the battery pack (116 model may only be used with two batteries of the 20 V series)
- Make sure that there are no obstructions in contact with the guide bar and the chain.
- Pull the brake baffle toward the battery pack and ensure that it remains in the working position (see fig. 2a).
- Hold the front handle with your left hand, and hold the rear handle with your right hand.
- Push forward the lock-off button and hold the trigger switch so that the chain saw is started (see fig. 2b).

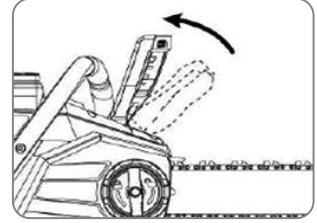

Fig. 2a

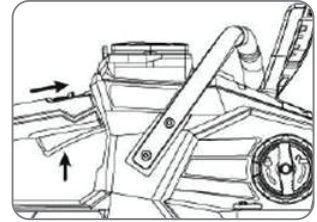

Fig. 2b

STOPPING THE CHAIN SAW

- Remove the chain saw from the cutting area, release the trigger switch and stop the chain saw.
- Push the brake baffle forward to switch it to the braking position.



ATTENTION – DANGER!



The tool runs for approximately 4 seconds after it has been switched off. Let the motor come to a complete standstill before setting the tool down.

PROPER GRIP ON HANDLES

- Wear non-slip gloves for maximum grip and protection.
- With the saw on a firm, flat surface, hold the saw firmly with both hands.
- Always grasp the front handle with the left hand and the rear handle with the right hand.
- The fingers should encircle the handle, with the thumb wrapped under the front handle (see fig. 3).

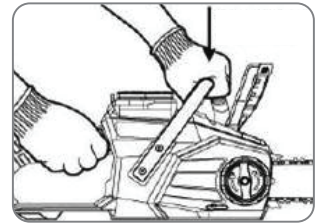

Fig. 3

CHAIN TENSION

13



ATTENTION – DANGER!



To avoid possible serious injury, never touch or adjust the chain while the motor is running. The saw chain is very sharp, always wear protective gloves when performing maintenance to the chain.

Regularly tightening the saw chain provides safety for the user and reduces and/or prevents wear and chain damages. Before the start of work and in approx. 10-minute intervals, we recommend the user to examine the chain tension and correct it, if necessary. The chain warms up when working with the saw and thus expands slightly. These “expansions” can be expected especially from newer chains.



WARNING!



Do not re-tighten or change the chain when it is hot because it shrinks slightly once it has cooled down. In case of non-observance, this can lead to damages on the guide rail or the engine because now the chain is too taut on the blade. Chain tension and chain lubrication have a significant impact on the service life of the chain.

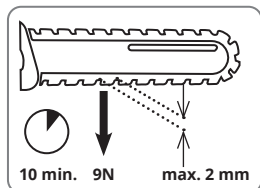

The chain is correctly tensioned if it does not sag at the rail underside and can be rotated completely around with the gloved hand. When the saw chain is tensioned with 9 N (approx. 1 kg), the gap between the saw chain and the guide rail may not be more than 2 mm.

MODEL KS CS20V-12

1. Stop the motor and remove the battery pack before adjusting the chain tension.
2. Loosen the side cover knob.
3. Turn the chain-tensioning knob clockwise to tension the chain. See the section: “replacing the bar and chain” in this manual for additional information.
4. Chain must be re-tensioned whenever the flats on the drive links hang out of the bar groove (see fig. 4).
5. During normal operation, the temperature of the chain will increase. The drive links of a correctly tensioned warm chain will hang approximately 2 mm. out of the bar groove (see fig. 5).
6. Retighten the side cover knob.

Fig. 4

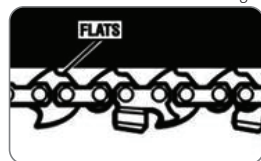
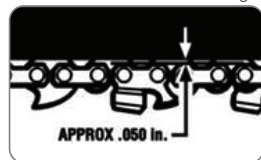

Fig. 5





NOTE



A cold chain is correctly tensioned when there is no slack on the underside of the guide bar, the chain is snug, but it can be turned by hand without binding.

MODELS KS CS40V-14, KS CS40V-16

1. Ensure that the chain brake has been released, that is, that the chain brake lever (5) is pulled up against the front grip (4).
2. Unscrew the fastening bolt (11) .
3. To tension the saw chain, turn the screw (12) for the chain quick-tensioning system in clockwise direction. To loosen the tension, turn the screw (12) in counter-clockwise direction.
4. Tighten up the fastening bolt (11) again .



NOTE



New chain tends to stretch; check chain tension frequently and tension as required.



NOTICE



Chain tensioned while warm, can be too tight upon cooling. Check the “cold tension” before next use.

1. Remove the battery pack from the chainsaw.
 2. Release the guide plate locking knob counter clockwise and open the side cover (see fig. 6).
 3. Rotate the disk wheel at the rear end of the guide plate counter-clockwise and remove the guide bar and the saw chain.
 4. Install the saw chain in the guide slot on the guide bar (see fig. 7).
- The chain must be so fitted over the guide bar that the cutting edges of the cutters face in the direction that the chain runs (see fig. 8).
5. Grasp the guide bar and the saw chain so that the centre hole of the disk wheel is inserted into the screw stud, and lop the saw chain onto the sprocket (see fig. 9).
 6. Cover the side cover and tight the side cover lock knob properly but do not make it too tight.
 7. Rotate the chain tensioning ring clockwise until the saw chain is tight enough (see the description of the chainsaw tension adjustment section).
 8. Tighten the side cover lock knob (see fig.10).

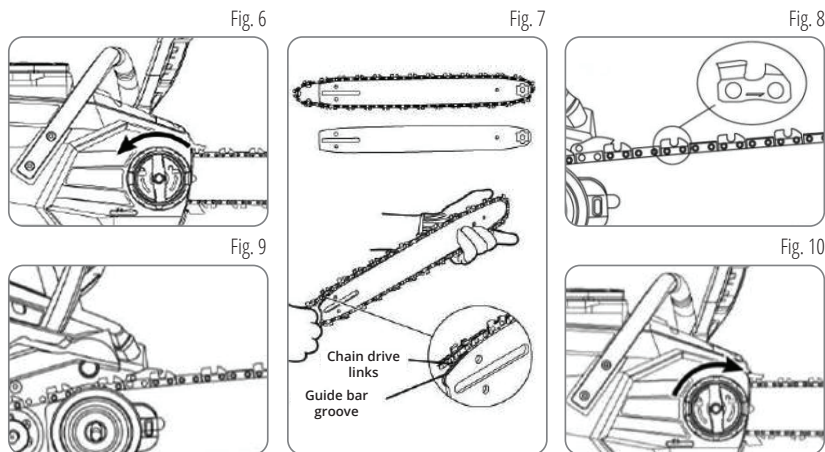

Machine part	Action	Before every use	After 10 hours of operation
Components of the chain brake	Check, replace if required	✓	
Sprocket chain wheel (B20)	Check for wear/indentations, replace if necessary	✓	
Saw chain (B6)	Check oil, regrind or replace if required	✓	
Guide bar (B7)	Check, clean and oil	✓	
	Turn around		✓
Automatic oil system	Check, clean oil aperture if necessary	✓	

SHARPENING THE SAW CHAIN

16

**ATTENTION – DANGER!**

A properly sharpened saw chain is crucial to minimize kickback danger. Always wear cut-protection gloves when handling the chain or chain bar.

**NOTE**

A sharp chain provides efficient cutting, slicing through wood easily, producing large, long chips. A blunt chain requires a strong pressure on the saw, which may cause the engine overload.

The chain's cutting parts include a cutting tooth and a depth gauge. The vertical distance between these components defines the cutting depth. Keep in mind the following specifications when sharpening the cutting teeth:

- Top-plate cutting angle (30°)
- Side-plate angle (85°)
- Depth gauge setting (0.65 mm)

**ATTENTION – DANGER!**

Deviating from the specified cutting geometry increases kickback risk.

Sharpening the saw chain requires expertise and specific tools to maintain correct angles and depth. Follow the instructions for sharpening chain. For those inexperienced with chainsaw maintenance, it's advisable to have the chain sharpened or replaced by a professional.

1. Turn off the saw and disconnect the battery.
2. Use a 4.0 mm round file for sharpening.

**WARNING!**

Using other diameters can damage the chain and increase operational risks!

4. Always file from the inside out, guiding the file from the inside of the tooth outward and lifting the file on the return stroke.
5. Start by sharpening the teeth on one side, then turn the saw to sharpen the other side.
6. Post-sharpening, all cutting elements should be uniform in length.
7. Every third sharpening, check and file the depth gauge to maintain the correct setting of 0.65 mm below the cutting tooth, rounding off the front edge slightly after adjustment.

GUIDE BAR MAINTENANCE

17

When the guide bar shows signs of wear, regularly approximately after 10 hours working time reverse it on the saw to distribute the wear for maximum bar life. The bar should be cleaned every day of use and checked for wear and damage.

Feathering or burring of the bar rails is a normal process of bar wear. Such faults should be smoothed with a file as soon as they occur.

A bar with any of the following faults should be replaced:

- Wear inside the bar rails which permits the chain to lay over sideways. Bent guide bar.
- Cracked or broken rails.
- Spread rails.

Lubricate guide bars with a sprocket at their tip weekly. Using a grease syringe, lubricate weekly in the lubricating hole. Turn the guide bar and check that the lubrication holes and chain groove are free from impurities.

The following form lists the common operating system with problem and solutions. Please read the form carefully and follow it.

Problems	Possible causes	Solution
Chain saw does not cut properly	<ul style="list-style-type: none"> • Dull chain. • Chain installed backwards. • Worm chain. • Excessively stretched chain. 	<ul style="list-style-type: none"> • Sharpen the chain. • Replace the chain, following the section: "Replacing the bar and chain". • Reinstall the saw chain, following the section: "Replacing the bar and chain". • Re-tension the saw chain, see the section: "Chain tension".
Bar and chain running hot and smoking	<ul style="list-style-type: none"> • Check chain tension for over tightened condition. • Chain oil tank is empty. 	<ul style="list-style-type: none"> • Re-tension the saw chain, see the section: "Chain tension". • Add oil to lubricate the chain.
Motor does not run	<ul style="list-style-type: none"> • The battery pack is not attached to the chain saw. • There is no electrical contact between the saw and battery. • The battery pack is depleted. • The battery pack or chain saw is too hot. • The back-off button is not depressed before pressing the trigger switch. • Chain brake is engaged. • Saw chain is bound in the wood. • Debris in bar groove. • Debris inside cover. 	<ul style="list-style-type: none"> • Attach the battery pack to the chainsaw. • Remove the battery, check contacts and reinstall the battery pack. • Charge the battery pack. • Allow the battery pack or chainsaw to cool. • Press down the lock-off button and hold it, then depress the trigger switch to turn on the chain saw. • Pull the chain kickback brake handle backward toward the front handle. • Release the trigger switch; remove the saw chain and guide bar from the wood, then restart the chain saw. • Forth to discharge the debris. • Remove battery pack, then remove side cover and clean out debris.
Motor runs, but chain does not rotate	<ul style="list-style-type: none"> • Chain does not engage drive sprocket. 	<ul style="list-style-type: none"> • Reinstall the chain, making sure that the drive links on the chain are fully seated on the sprocket.
Chain brake does not engage	<ul style="list-style-type: none"> • Debris preventing full movement of the chain kickback brake handle. 	<ul style="list-style-type: none"> • Clean debris from extremal chain brake mechanism.

WARRANTY SERVICE TERMS

19

The international manufacturer warranty is 1 year. The warranty period starts from the date of purchase. In cases when warranty period is longer than 1 year according to local legislation please contact your local dealer. The Seller which sells the product is responsible for granting the warranty. Please contact the Seller for warranty. Within the warranty period, if the product fails because of defects in the production process, it will be exchanged on the same product or repaired.

All faults caused by the manufacturer during the warranty period will be eliminated free of charge. Warranty repair is carried out only if you have a fully completed warranty card, the Buyer's signature of acceptance of the warranty terms, as well as a document supporting the purchase (cash receipt, sales slip or invoice). In the absence thereof, as well as in the event of errors or corrections not authenticated by the seller's seal or illegible inscriptions in the warranty card or tear-off coupon, no warranty repair is carried out, no objections to quality are accepted and the warranty card is withdrawn by the service center as invalid. The device is accepted for repair clean and full.



MODEL KS CS20V-12

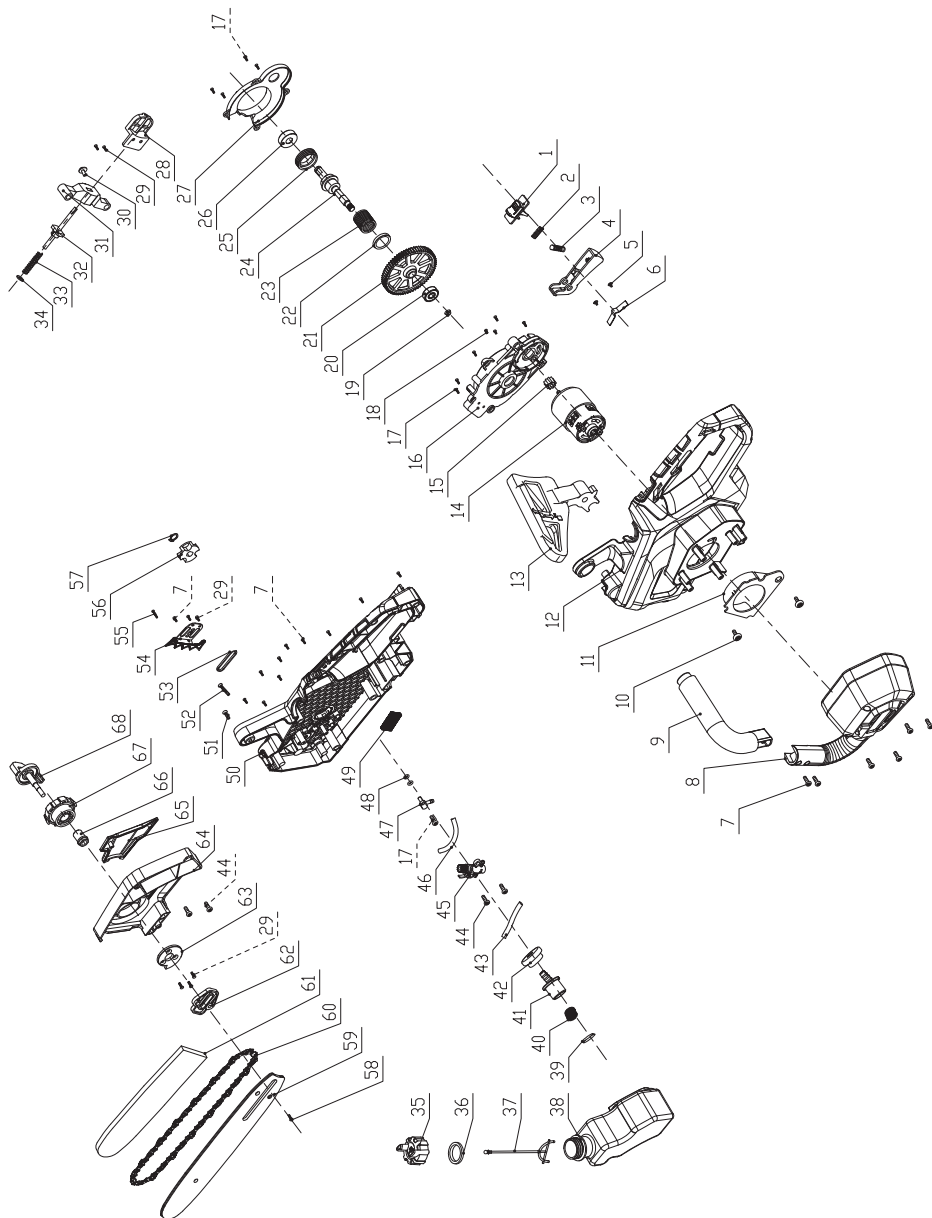



MODELS KS CS40V-14, KS CS40V-16

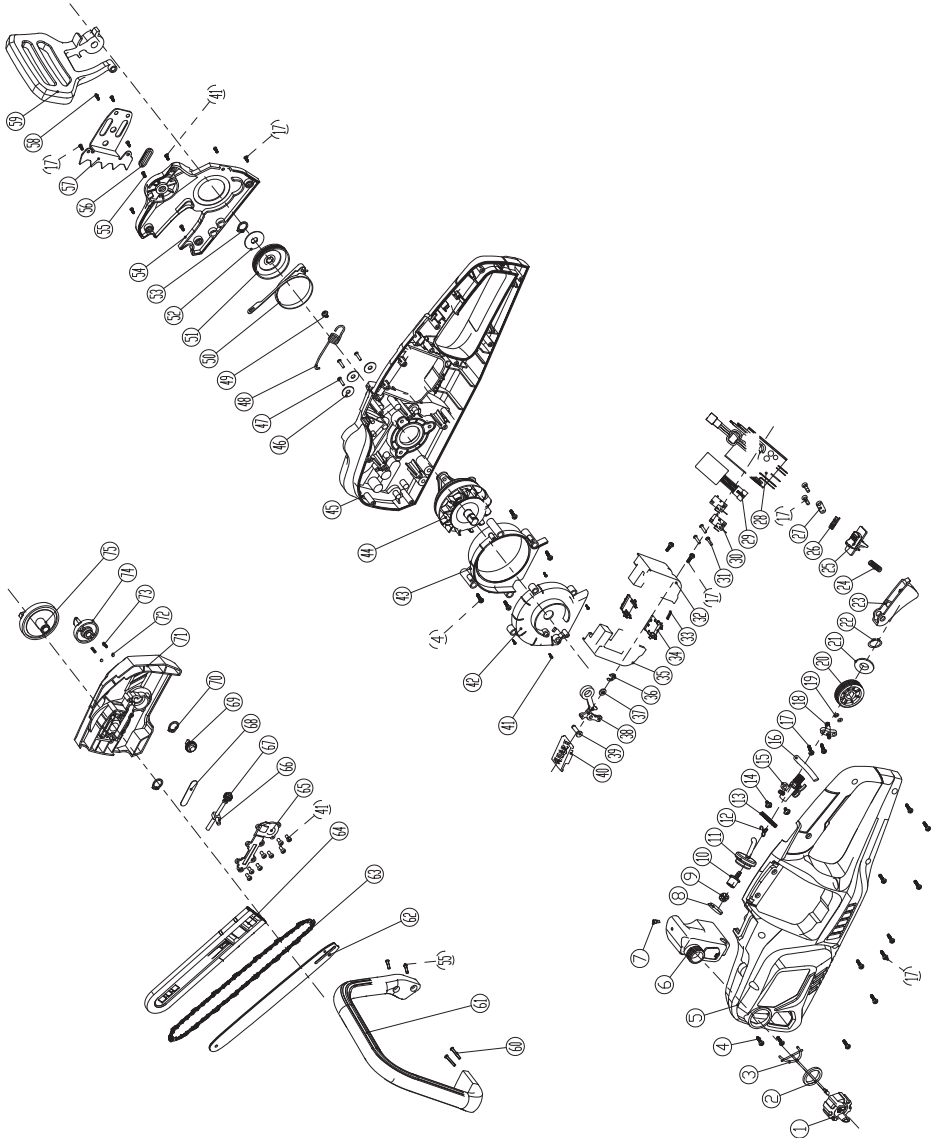



EC Declaration of Conformity

Nr. 171

The following products have been tested by us with the listed standards and found in compliance with the European Community Directive 2014/30/EU relating to electromagnetic compatibility, Directive 2006/42/EC relating to machinery.

Manufacturer: DIMAX INTERNATIONAL GmbH
Address: Flinger Broich 203, 40235 Duesseldorf, Germany

Product: Cordless chainsaw "Könner & Söhnen"

Type / Model: KS CS20V-12, KS CS-40V (including modifications of model
KS CS40V: KS CS40V-14, KS CS40V-16)

The statement is based on a single evaluation of above mentioned products. It does not imply an assessment of the whole production and does not permit the use of the test lab. logo. The manufacturer should ensure that all product in series production are in conformity with the product sample detailed in this report. The applicant should hold the whole technical report at disposal of the competent all the right.

Applied EC Directives: 2014/30/EU Electromagnetic compatibility Directive (EMC)
2006/42/EC Machinery Directive

Applied Standards: EN 55014-1:2017/A11:2020
EN 55014-2:2015
EN IEC 55014-1:2021
EN IEC 55014-2:2021
IEC 62841-1: 2014, COR1:2014, COR2:201

2000/14/EC_2005/88/EC Annex VI

For model KS CS20V-12 Noise measured $L_{wa} = 93$ dB (A), guaranteed $L_{wa} = 96$ dB (A)

For model KS CS40V (including modifications of model KS CS40V: KS CS40V-14, KS CS40V-16):

Noise measured $L_{wa} = 102$ dB (A), guaranteed $L_{wa} = 105$ dB (A)



22

Issued Date: 2024-01-05
Place of issue: Duesseldorf
Director: Fomin P.

P. Fomin

DIMAX

International GmbH

Flinger Broich 203 40235 Düsseldorf

USt-ID DE296177274

koenner-soehnen.com

We DIMAX INTERNATIONAL GmbH hereby declare that specified above conforms covering European Parliament and Council Directives, 2006/42/EC of 17 May 2006 Machinery Directive, Electromagnetic compatibility Directive (EMC) 2014/30/EC of 26 February 2014. The CE mark above can be used under the responsibility of manufacturer. After completion of an EC declaration of Conformity and compliance with all relevant EC directives.

CONTACTS

Deutschland:

DIMAX International GmbH
Flinger Broich 203 -FortunaPark-
40235 Düsseldorf, Deutschland
www.koenner-soehnen.com

Ihre Bestellungen

orders@dimaxgroup.de

Kundendienst, technische Fragen und Unterstützung

support@dimaxgroup.de

Garantie, Reparatur und Service

service@dimaxgroup.de

Sonstiges

info@dimaxgroup.de

Polska:

DIMAX International
Poland Sp.z o.o.

Polska, Warczawska,
306B 05-082 Stare Babice,
info.pl@dimaxgroup.de

Україна:

ТОВ «Техно Трейд КС»,
вул. Електротехнічна 47, 02222,
м. Київ, Україна

sales@ks-power.com.ua
